

BEST CONTACTS FOR YOUR SUCCESS



Telegärtner

KARL GÄRTNER GMBH

NETWORKING COMPONENTS

COAXIAL CONNECTORS

CABLE ASSEMBLIES

PRECISION TURNED PARTS

PLASTIC INJECTION MOULD PARTS

INDUSTRIAL ELECTRONICS



Coax

TestLine

RF Components for

- Production Line Testing
- Lab Test and Measurement
- Field Test and Measurement

TestLine – RF Components for Test and Measurement

Under the brand name "TestLine", Telegärtner has developed an extensive portfolio for various test and measurement requirements. The TestLine components can be used in lab and field test and measurements as well as production line testing.

Telegärtner has now substantially expanded the range. With the new TestLine 4LL test cables, measurements up to 40 GHz are now possible. Just like the 5LL types, the 4LL test cables offer exceptional electrical properties and mechanical protection.

In the field of precision adaptors and connectors, Telegärtner

offers components for measurements up to 40 GHz. These precision adaptors are types: 2.92 mm, 3.5 mm, SMA and N. For PCB solutions, 2.92 mm and SMA types are offered in End Launch and Edge Mount styles.

Termination loads have been expanded with the 4.3-10 series.

Furthermore Telegärtner offers some particular highlights: A Port Saver to protect the sensitive jacks on the equipment and Quick/ Push-on Adaptors for secure and quick measurements in short intervals.

TestLine Fields of Application

Lab test and measurement

Applications in the laboratory require a high level of quality and precision. For R&D sites and company labs Telegärtner offers solutions for almost every requirement – from high quality measurement cables, through termination loads to precision adaptors.



Production Line Testing

For production line testing in factories and production sites, measurements should be carried out quickly and reliably. In harsh environments, mechanical stability, robustness, and longevity without loss in the signal quality are required.



Field test and measurement

Tests and measurements in the field require resistance to external influences. Also just as crucial are good handling and quick installation in the field.



TestLine Components

TestLine Cables

The high quality TestLine RF measurement cables have a particularly effective cable protection against mechanical stress while at the same time satisfying the highest requirements for electrical transmission characteristics regarding attenuation, phase stability and life span.

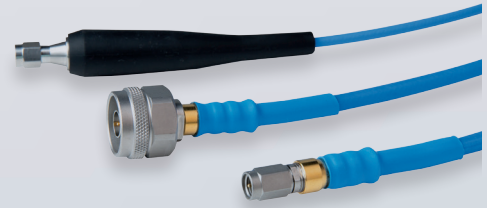

PCB Precision Connectors

PCB precision connectors allow tests and measurements to be carried out on PCBs. This can mostly be found in applications in test labs and R&D sites. Edge mount and End launch versions are available for 2.92 mm and SMA types up to 40 GHz and 27 GHz respectively.

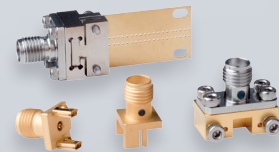

Precision Adaptors

Telegärtner offers a range of high quality 2.92 mm, 3.5 mm, SMA and N precision adaptors for test purposes, which can be used for almost every requirement. The TestLine adaptors are specially designed for a high number of mating cycles and have excellent RF properties.

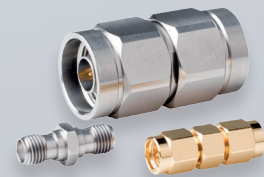

Quick Push-On Test Adaptors / Port Savers

By using port savers you spare the sensitive jacks on the equipment from wear and tear and avoid the costly exchange of these connectors. The port saver is available for 2.92 mm, SMA, N and 7-16 types.

The use of the Quick/Push-on Test Adaptors allows a marked reduction in connection time. As such, these products lend themselves perfectly to test beds and production lines.



Termination Loads

Telegärtner offers a wide variety of high quality TestLine 4.3-10, 7-16, N, TNC, BNC, SMA and R-SMA termination loads. The termination loads are used to test and terminate RF transmitters and amplifiers.



Attenuators

The Telegärtner TestLine attenuators are used to weaken RF signals. Up to a frequency of 6 GHz, a precise signal attenuation of 3, 6, 10 or 20 dB depending on type is achieved. Application fields for attenuators in test and measurement are where the RF performance needs to be set at certain levels.



TestLine Cables

The TestLine RF Test Cable assemblies have been designed with high specifications regarding attenuation, phase stability and life span for test and measurement purposes. The connectors, which have been specifically designed for this purpose, have a special connection process for low, stable VSWR as well as a particularly effective cable protection against mechanical stress. In addition the connector bodies and nuts are made

from stainless steel, which offers a very high number of mating cycles.

The TestLine cables are therefore perfect for use in lab or production areas, in which a high number of reliable signal tests need to be undertaken.

Telegärtner offers 2 types: 5LL for measurements up to 18 GHz (SMA, N and 7-16) and 4LL for measurements up to 40 GHz (2.92 mm). Each cable is tested separately and delivered with a test report.



Features of the TestLine Cables

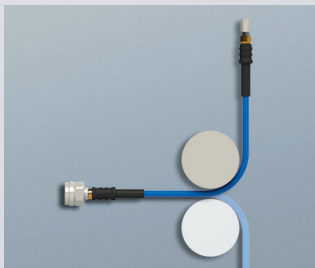

Stability

The special structure of the RF cable with a foam PTFE dielectric guarantees excellent phase stability and return loss stability even when the cable is bent as required.

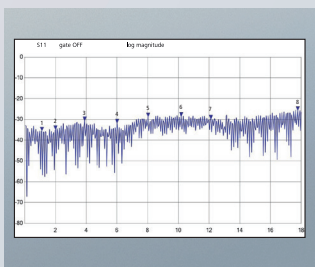

Excellent electrical Values

for frequencies up to 18 GHz (SMA) or 11 GHz (N) with low return loss (-23 dB at 18 GHz). The maximum cable attenuation is only 1.0 dB/m at 18 GHz.

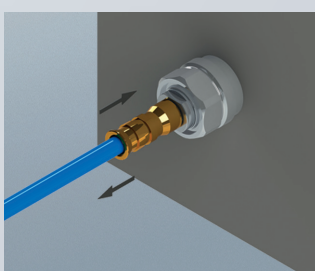

High Number of Mating Cycles

while the transmission properties remain the same thanks to the gold plated centre conductor and a stainless steel body and nut.

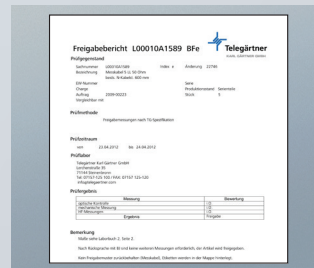

100% Tested

Every cable is supplied with a detailed test report.

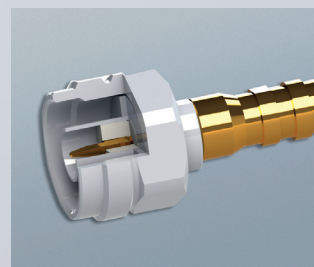

Precision Connector

TestLine cables are manufactured with connectors designed specifically for test and measurement requirements.

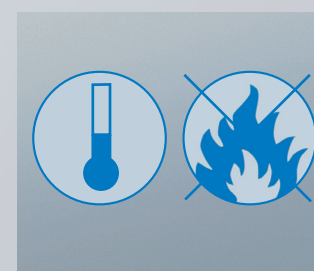

Heat resistant and flame retardant

Temperature range
-54 °C bis +135 °C

Construction of TestLine Cables

TestLine Connector Design

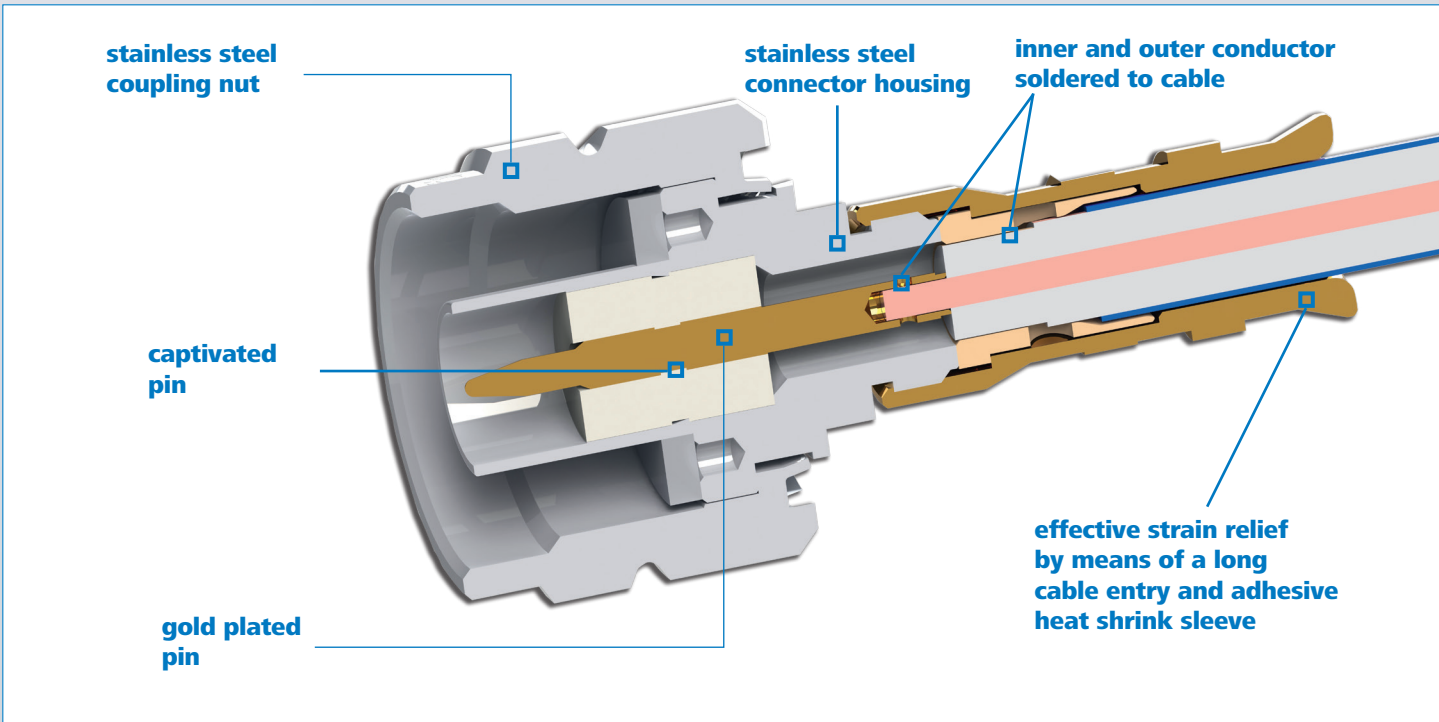

TestLine Cable Construction

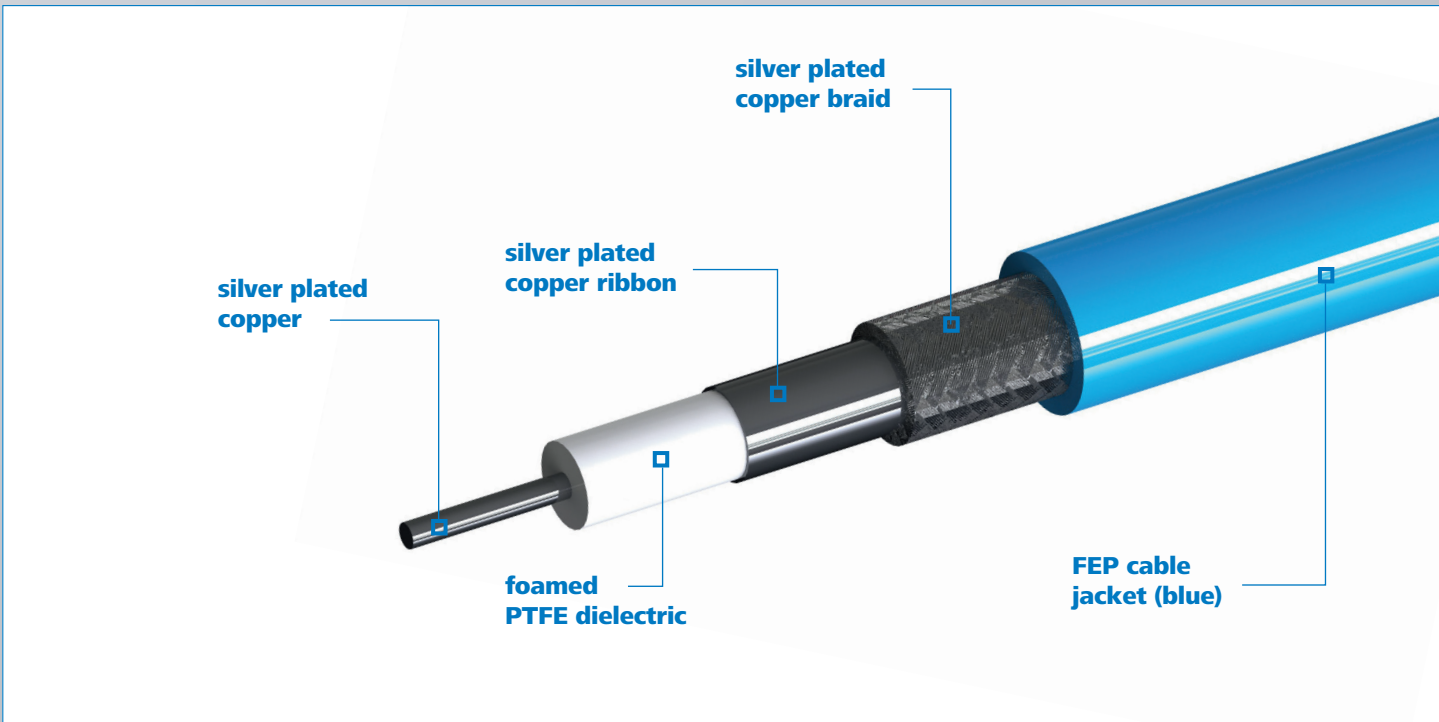

TestLine Cables 4LL 40 GHz

The high quality 4LL test and measurement cables from the Test-Line Series have been designed for RF measurements up to 40 GHz. Thanks to the specially chosen materials and the excellent workmanship, very good attenuation can be achieved at high frequencies. Provided with a solid and stable strain relief, the TestLine 4LL cables are protected at the termination point from high pressure loads.

4LL test and measurement cables are available in standard lengths of 600 mm, 1000 mm and 1500 mm. Special lengths are available on request.

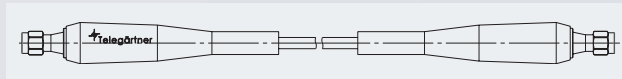

| Order no. | Description | Frequency | Length |
|-------------|--------------------------------|-----------|----------|
| L00010A1782 | TestLine 4LL cable 2.92 – 2.92 | 40 GHz | 600 mm |
| L00010A1783 | TestLine 4LL cable 2.92 – 2.92 | 40 GHz | 1.000 mm |
| L00011A0480 | TestLine 4LL cable 2.92 – 2.92 | 40 GHz | 1.500 mm |

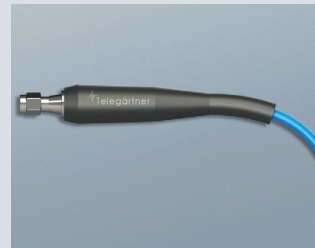

Bend Protection

Due to a specially strengthened strain relief, all 4LL test cables are protected against strain due to sharp bends at the termination point.

Mechanical Characteristics

| | |
|--------------------------|-------------------|
| cable bending radius | > 19 mm |
| cable sheath | FEP, Ø 4,2 mm |
| connector center contact | CuBe, gold-plated |
| connector outer contact | stainless steel |
| coupling nut | stainless steel |
| plugging cycles | min. 500 |
| operation temperature | -55 °C to +135 °C |

Electrical Characteristics

| | |
|---|---|
| connector type | 2.92mm |
| impedance | 50 Ohm |
| frequency range | < 40 GHz |
| return loss (typical) | up to 4 GHz: -33 dB up to 10 GHz: -25 dB up to 18 GHz: -18 dB up to 26 GHz: -18 dB up to 40 GHz: -16 dB |
| max. cable attenuation (@40GHz) | 2,4 dB/m |
| screen effectiveness | -100 dB max. |
| phase stability (measured after 90° bend) | < 4° @ 40GHz |
| insertion loss (dB/m) | 0,33 @ 1 GHz 0,99 @ 6 GHz 1,12 @ 10 GHz 1,58 @ 18 GHz 1,94 @ 26 GHz 2,48 @ 40 GHz |

Return Loss TestLine Cables 4LL

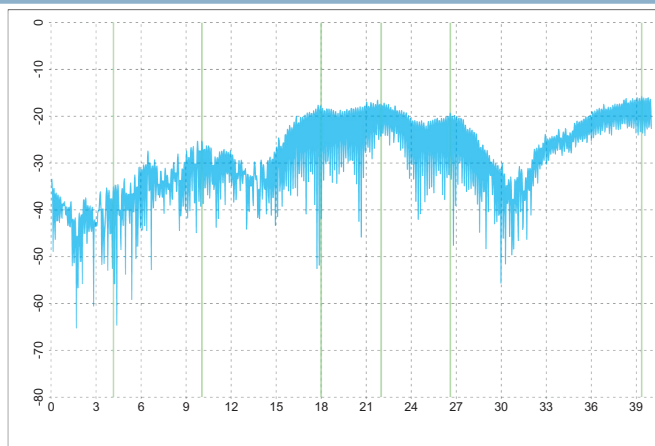

| marker | stimulus | value |
|--------|------------|-----------|
| 1 | 4,161 GHz | -35,14 dB |
| 2 | 10,055 GHz | -25,40 dB |
| 3 | 18,000 GHz | -26,69 dB |
| 4 | 22,000 GHz | -22,92 dB |
| 5 | 26,609 GHz | -19,66 dB |
| 6 | 39,357 GHz | -16,15 dB |

TestLine Cables 5LL 18 GHz

The TestLine 5LL cables have been specially designed for test processes with constantly changing test subjects and therefore high mating cycles. The high end test cables show excellent transmission properties for the demanding usage in test labs and production tests.

The specially designed 5LL cables from Telegärtner offer extra strong protection against external stresses. The cable protection is made from a spiral steel wire with an extremely high pressure load of up to 80 kg/5 cm of cable length. Damage to the cable by kinking or crushing is thereby minimized.

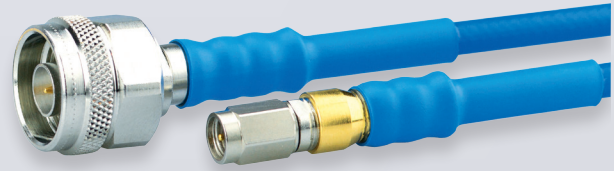
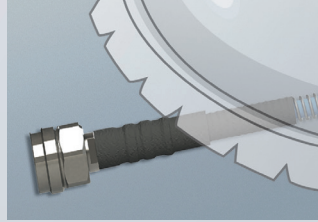
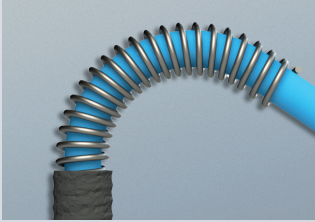



Available standard lengths are 600 mm and 1000 mm. Special lengths on request.

Cable Protection

TestLine Cables have the option of being fitted with a stainless steel wire coil. This coil protects the cable from mechanical stress up to 80 kg/5 cm of cable.

Use of this cable protection is particularly useful in production areas, field tests and also in labs where mechanical stress can't be ruled out.

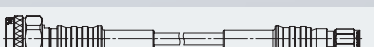
| | Order no. | Description | Remarks | Frequency | Length |
|--|-------------|------------------------------|------------------------|-----------|--------|
|  | L00010A1588 | TestLine 5LL cable SMA – SMA | Standard | 18 GHz | 600 mm |
| | L00010B1588 | TestLine 5LL cable SMA – SMA | with impact protection | 18 GHz | 600 mm |
|  | L00010A1589 | TestLine 5LL cable N – N | Standard | 11 GHz | 600 mm |
| | L00010B1589 | TestLine 5LL cable N – N | with impact protection | 11 GHz | 600 mm |
|  | L00010A1590 | TestLine 5LL cable N – SMA | Standard | 11 GHz | 600 mm |
| | L00010B1590 | TestLine 5LL cable N – SMA | with impact protection | 11 GHz | 600 mm |

Mechanical Characteristics

| | |
|--------------------------|------------------------|
| cable bending radius | > 30 mm |
| cable sheath | FEP, Ø 5,4 mm |
| connector center contact | CuZn39Pb3, gold-plated |
| connector outer contact | stainless steel |
| coupling nut | stainless steel |
| plugging cycles | min. 1000 |
| operation temperature | -55 °C to +110 °C |

Electrical Characteristics

| | |
|---|---|
| connector types | SMA, N special design |
| impedance | 50 Ohm |
| frequency range | SMA: < 18 GHz N: < 11 GHz |
| return loss (typical) | up to 4 GHz: -28 dB up to 10 GHz: -24 dB up to 18 GHz: -20 dB |
| max. cable attenuation (@40GHz) | 1,0 dB/m |
| screen effectiveness | -110 dB max. (@ 1 GHz) |
| phase stability (measured after 90° bend) | < 1,5° @ 4 GHz - 18 GHz |
| insertion loss (dB/m) | 0,22 @ 1 GHz 0,41 @ 4 GHz 0,68 @ 10 GHz 0,94 @ 18 GHz |

Return Loss TestLine Cables 5LL

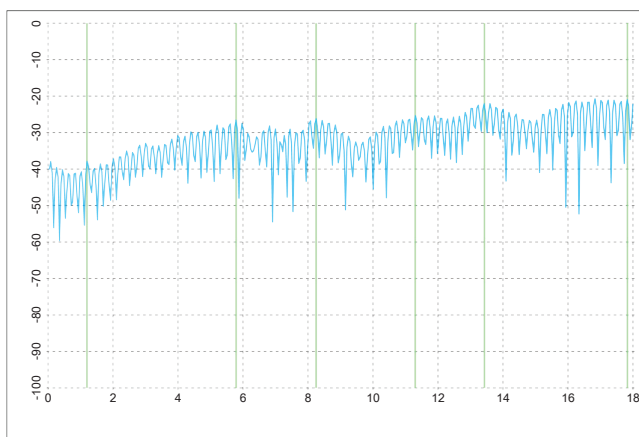



| marker | stimulus | value |
|--------|------------|-----------|
| 1 | 1,200 GHz | -38,52 dB |
| 2 | 5,790 GHz | -26,84 dB |
| 3 | 8,250 GHz | -26,84 dB |
| 4 | 11,300 GHz | -25,88 dB |
| 5 | 13,430 GHz | -22,69 dB |
| 6 | 17,830 GHz | -21,40 dB |

PCB Precision Connectors

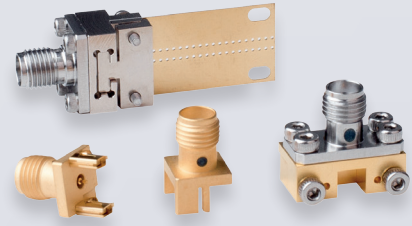
PCB precision connectors are mainly used in R&D applications. With Edge Mount and End Launch Telegärtner offers two different mounting options for this area. Compared to the standard versions, precision connectors are designed for precise measurements at high frequencies. End Launch types are also available in the "Quick" model, which allows the connectors to be connected quickly and repeatedly to the PCB.

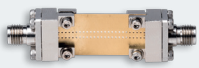

| Series | Order no. | Description | Type | Return loss (typ.) | Max. frequency |
|---|-------------|---|------|---|----------------|
| SMA  | J01151A1401 | SMA End Launch Solder Type | f | ≤ -16 dB | 27 GHz |
| SMA  | J01151A1411 | SMA Quick End Launch Quick Push-on Type | f | ≤ -14 dB | 18 GHz |
| SMA and 2.92 mm  | J01151A1386 | SMA Edge Mount Screw-on Type | f | 2 GHz: -23 dB; 11 GHz: -22 dB; 18 GHz: -18 dB; 27 GHz: -15 dB | 27 GHz |
| | J01531A0000 | 2.92 mm Edge Mount Screw-on Type | f | 2 GHz: -24 dB; 11 GHz: -24 dB; 18 GHz: -20 dB; 27 GHz: -15 dB; 33 GHz: -15 dB; 40 GHz: -15 dB | 40 GHz |

Precision Adaptors

Telegärter has extended its portfolio with high quality precision adaptors, which, depending on the type, can be used in frequency bands up to 40 GHz. They can be used on almost all measuring equipment. All precision adaptors have excellent RF properties and thanks to a stainless steel body, a high number of mating cycles.

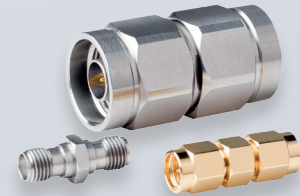

| Series | Order no. | Description | Type | Return loss (typ.) | Max. frequency |
|--|-------------|-------------------------------|------|---|----------------|
| 2.92 mm  | J01532A0000 | 2.92 mm precision adaptor | m-m | 2 GHz: -33 dB; 11 GHz: -27 dB; 27 GHz: -25 dB; 40 GHz: -18 dB | 40 GHz |
| | J01532A0001 | 2.92 mm precision adaptor | m-f | 2 GHz: -38 dB; 11 GHz: -27 dB; 27 GHz: -25 dB; 40 GHz: -18 dB | 40 GHz |
| | J01532A0002 | 2.92 mm precision adaptor | f-f | 2 GHz: -38 dB; 11 GHz: -27 dB; 27 GHz: -25 dB; 40 GHz: -18 dB | 40 GHz |
| 3.5 mm  | J01522A0000 | 3.5 mm precision adaptor | m-m | 2 GHz: -33 dB; 11 GHz: -27 dB; 18 GHz: -23 dB; 27 GHz: -20 dB | 27 GHz |
| | J01522A0001 | 3.5 mm precision adaptor | m-f | 2 GHz: -33 dB; 11 GHz: -27 dB; 18 GHz: -23 dB; 27 GHz: -20 dB | 27 GHz |
| | J01522A0002 | 3.5 mm precision adaptor | f-f | 2 GHz: -36 dB; 11 GHz: -27 dB; 18 GHz: -23 dB; 27 GHz: -20 dB | 27 GHz |
| SMA  | J01154A0086 | SMA precision adaptor | m-m | 2 GHz: -33 dB; 6 GHz: -30 dB; 11 GHz: -27 dB; 18 GHz: -27 dB | 18 GHz |
| | J01154A0061 | SMA precision adaptor | m-f | 2 GHz: -38 dB; 6 GHz: -25 dB; 11 GHz: -23 dB; 18 GHz: -22 dB; | 18 GHz |
| | J01154A0096 | SMA precision adaptor | f-f | 2 GHz: -40 dB; 6 GHz: -33 dB; 11 GHz: -23 dB; 18 GHz: -20 dB | 18 GHz |
| N  | J01024A0013 | N precision adaptor | m-m | 2 GHz: -40 dB; 6 GHz: -36 dB; 11 GHz: -32 dB; 18 GHz: -26 dB | 18 GHz |
| N to SMA  | J01027T0018 | measuring adaptor N-SMA, 50 Ω | m-f | 2 GHz: -40 dB; 6 GHz: -30 dB; 11 GHz: -30 dB; 18 GHz: -20 dB | 18 GHz |
| | J01027T0017 | measuring adaptor N-SMA, 50 Ω | f-f | 2 GHz: -40 dB; 6 GHz: -28 dB; 11 GHz: -28 dB; 18 GHz: -20 dB | 18 GHz |
| | J01027T0019 | measuring adaptor N-SMA, 50 Ω | m-m | 2 GHz: -40 dB; 6 GHz: -28 dB; 11 GHz: -28 dB; 18 GHz: -20 dB | 18 GHz |
| | J01027T0016 | measuring adaptor N-SMA, 50 Ω | f-m | 2 GHz: -40 dB; 6 GHz: -28 dB; 11 GHz: -28 dB; 18 GHz: -20 dB | 18 GHz |

Quick Push-On Adaptor

The Quick/Push-On adaptors can be used wherever reliable measurements have to be carried out in short intervals. Tests can be carried out more effectively through quicker connecting and disconnecting of the test cable. Quick/Push-On adaptors are mostly used in test labs and also on production lines.





Usage of Quick/Push-On Adaptors



Testport



Quick/Push-On Adaptor on Measuring Cable

| Series | Order no. | Description | Type | Return loss (typ.) | Max. frequency |
|---|-------------|--------------------------------------|------|---|----------------|
| SMA  | J01155A0099 | SMA Push-On Test Adaptor, 50 Ohm | m-f | 1 GHz: -34 dB; 3 GHz: -27 dB; 6 GHz: -27 dB; 10 GHz: -20 dB; 18 GHz: -18 dB | 18 GHz |
| N  | J01024A0010 | N Quick Connect Test Adaptor, 50 Ohm | m-f | 2 GHz: -35 dB; 6 GHz: -28 dB; 11 GHz: -25 dB | 11 GHz |
|  | J01024A0011 | N-Push-On Test Adaptor, 50 Ohm | m-f | 2 GHz: -35 dB; 6 GHz: -28 dB; 11 GHz: -25 dB | 11 GHz |

Port Saver

Port savers are used to protect the test ports of expensive test equipment. Swapping out jacks in expensive test equipment is cost-intensive and time-consuming. In order to avoid this, the Telegärtner Port Saver is con-

nected to the original port, so that it doesn't get damaged even when used regularly. The port saver can be replaced quickly and economically when required.

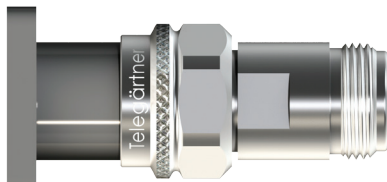

Usage of Port Savers

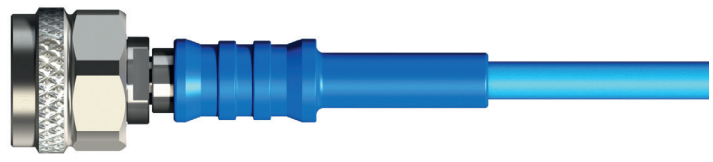

Jack on the equipment with Port Saver

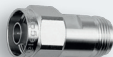

Measuring Cable

| Series | Order no. | Description | Type | Return loss (typ.) | Max. frequency |
|--|-------------|--|------|--|----------------|
| N  | J01024A0009 | N Test Adaptor (Port Saver), 50 Ohm | m-f | 2 GHz: -35 dB; 6 GHz: -28 dB; 11 GHz: -25 dB | 11 GHz |
| 7-16  | J01123B0006 | 7-16 Test Adaptor (Port Saver), 50 Ohm | m-f | 1 GHz: -43 dB; 2 GHz: -31 dB; 6 GHz: -29 dB | 6 GHz |

Termination Loads

Termination loads are connected as a load to an open signal output or an RF line in order to avoid reflection. They are available with an impedance of 50 Ohms. The performance spectrum of the termination loads varies between 1 W and 625 W up to maximum frequencies of 18 GHz. Termination loads are used for example on open ports on transmitters as well as in the calibration of RF test equipment.

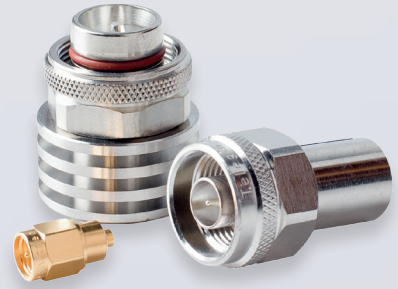

Electrical Characteristics Series SMA / R-SMA

| | |
|-----------------|---|
| impedance | 50 Ω |
| frequency range | < 18 GHz (SMA) < 6 GHz (R-SMA) |
| return loss | 2 GHz: 34 dB 6 GHz: 23 dB 18 GHz: 17 dB |
| max. power | 1 Watt |

Electrical Characteristics Series 4.3-10

| | |
|-----------------|--|
| impedance | 50 Ω |
| frequency range | < 7,5 GHz |
| return loss | 1,0 GHz: 40 dB 2,5 GHz: 35 dB 7,5 GHz: 21 dB |
| max. power | 2 Watt |

Electrical Characteristics Series BNC

| | |
|-----------------|---------------|
| impedance | 50 Ω |
| frequency range | < 4 GHz |
| return loss | 4 GHz: 24 dB |
| max. power | 1 res. 2 Watt |

Electrical Characteristics Series N







| | |
|-----------------|---|
| impedance | 50 Ω |
| frequency range | < 18 GHz |
| return loss | 4 GHz: 26 dB 6 GHz: 25 dB 18 GHz: 13 dB |
| max. power | 2 res. 10 Watt |

Electrical Characteristics Series TNC

| | |
|-----------------|--------------|
| impedance | 50 Ω |
| frequency range | < 6 GHz |
| return loss | 6 GHz: 21 dB |
| max. power | 1 Watt |

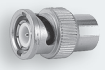
Electrical Characteristics Series 7-16

| | |
|-----------------|----------------|
| impedance | 50 Ω |
| frequency range | < 7.5 GHz |
| return loss | 2.5 GHz: 27 dB |
| max. power | 2 res. 10 Watt |

| Series | Order no. | Description | Max. Frequency | Max. Power |
|---|-------------|-----------------------------------|----------------|------------|
| SMA/R-SMA  | J01152A0011 | SMA termination load, plug | 6 GHz | 1 W |
| | J01152B0011 | SMA termination load, plug | 18 GHz | 1 W |
| | J01152R0011 | R-SMA termination load, plug | 6 GHz | 1 W |
| SMC  | J01176A0001 | SMC termination load, jack | 2 GHz | 1 W |
| BNC  | J01006A0020 | BNC termination load, plug | 4 GHz | 1 W |
| | J01006A0021 | BNC termination load, jack | 4 GHz | 1 W |
| TNC  | J01016A0002 | TNC termination load, plug | 6 GHz | 1 W |
| | J01016A0003 | TNC termination load, jack | 6 GHz | 1 W |
| N  | J01026A0012 | N termination load, plug | 6 GHz | 1 W |
| | J01026A0010 | N termination load, plug | 18 GHz | 2 W |
| | J01026A0013 | N termination load, jack | 6 GHz | 1 W |
| | J01026A0014 | N termination load, jack | 18 GHz | 2 W |
| | J01026A0011 | N termination load, plug | 18 GHz | 10 W |
| 7-16  | J01124A0001 | 7-16 termination load, plug | 7.5 GHz | 2 W |
| | J01124A0002 | 7-16 termination load, jack | 7.5 GHz | 2 W |
| | J01124A0003 | 7-16 termination load, plug | 7.5 GHz | 10 W |
| | J01124A0004 | 7-16 termination load, jack | 7.5 GHz | 10 W |
| 4.3-10  | J01444A0000 | 4.3-10 termination load Screw | 7,5 GHz | 2 Watt |
| | J01444A0001 | 4.3-10 termination load Screw | 6,0 GHz | 1 Watt |
| | J01444A3000 | 4.3-10 termination load Push-Pull | 7,5 GHz | 2 Watt |

Attenuators

Telegärtner attenuators are used to weaken RF signals. Up to a frequency of 6 GHz, a precise signal attenuation of 3, 6, 10 or 20 dB depending on type is achieved. Application fields for attenuators are in Antenna Lines (e.g. Mobile Communications and WiFi) and in test and measurement where the RF performance needs to be set at certain levels.

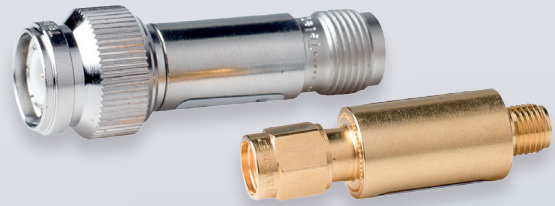

| Electrical Characteristics Series SMA | |
|---------------------------------------|--|
| impedance | 50 Ω |
| frequency range | 6 GHz |
| return loss | 1 GHz: 30 dB 3 GHz: 25 dB 6 GHz: 20 dB |
| max. power | 2 Watt |







| Electrical Characteristics Series N | |
|-------------------------------------|--|
| impedance | 50 Ω |
| frequency range | 6 GHz |
| return loss | 1 GHz: 30 dB 3 GHz: 25 dB 6 GHz: 20 dB |
| max. power | 2 Watt |

| Electrical Characteristics Series BNC | |
|---------------------------------------|--|
| impedance | 50 Ω |
| frequency range | 6 GHz |
| return loss | 1 GHz: 30 dB 3 GHz: 25 dB 6 GHz: 20 dB |
| max. power | 2 Watt |

| Electrical Characteristics Series R-TNC | |
|---|--|
| impedance | 50 Ω |
| frequency range | 6 GHz |
| return loss | 1 GHz: 30 dB 3 GHz: 25 dB 6 GHz: 20 dB |
| max. power | 2 Watt |

| Electrical Characteristics Series TNC | |
|---------------------------------------|--|
| impedance | 50 Ω |
| frequency range | 6 GHz |
| return loss | 1 GHz: 30 dB 3 GHz: 25 dB 6 GHz: 20 dB |
| max. power | 2 Watt |

| Electrical Characteristics Series R-SMA | |
|---|--|
| impedance | 50 Ω |
| frequency range | 6 GHz |
| return loss | 1 GHz: 30 dB 3 GHz: 25 dB 6 GHz: 20 dB |
| max. power | 2 Watt |

| Series | Order no. | Description | Attenuation nominal |
|---|-------------|-------------------------------|---------------------|
| SMA  | J01156A0011 | SMA attenuator, male-female | 3 dB |
| | J01156A0021 | SMA attenuator, male-female | 6 dB |
| | J01156A0031 | SMA attenuator, male-female | 10 dB |
| | J01156A0041 | SMA attenuator, male-female | 20 dB |
| BNC  | J01006A0022 | BNC attenuator, male-female | 3 dB |
| | J01006A0023 | BNC attenuator, male-female | 6 dB |
| | J01006A0024 | BNC attenuator, male-female | 10 dB |
| | J01006A0025 | BNC attenuator, male-female | 20 dB |
| TNC  | J01016A0004 | TNC attenuator, male-female | 3 dB |
| | J01016A0005 | TNC attenuator, male-female | 6 dB |
| | J01016A0006 | TNC attenuator, male-female | 10 dB |
| | J01016A0007 | TNC attenuator, male-female | 20 dB |
| N  | J01026A0018 | N attenuator, male-female | 3 dB |
| | J01026A0019 | N attenuator, male-female | 6 dB |
| | J01026A0020 | N attenuator, male-female | 10 dB |
| | J01026A0021 | N attenuator, male-female | 20 dB |
| R-TNC  | J01016R0004 | R-TNC attenuator, male-female | 3 dB |
| | J01016R0005 | R-TNC attenuator, male-female | 6 dB |
| | J01016R0006 | R-TNC attenuator, male-female | 10 dB |
| | J01016R0007 | R-TNC attenuator, male-female | 20 dB |
| R-SMA  | J01156R0011 | R-SMA attenuator, male-female | 3 dB |
| | J01156R0021 | R-SMA attenuator, male-female | 6 dB |
| | J01156R0031 | R-SMA attenuator, male-female | 10 dB |
| | J01156R0041 | R-SMA attenuator, male-female | 20 dB |

More Customised: assembling RF cables online

Do you want to assemble RF cables with coaxial connectors individually and add strain relief, labelling and cable length according to your requirements? Then the COAX configurator developed by Telegärtner is just what you need:

- ... **simple**, and is available to you around the clock
- ... **fast**, and allows you to configure your customised assembly with just a few clicks, thanks to a logical and easy-to-understand user-guidance
- ... **user-orientated**, and offers you exactly the information you require in order to configure your individual cable assembly

User-friendly input mask ...

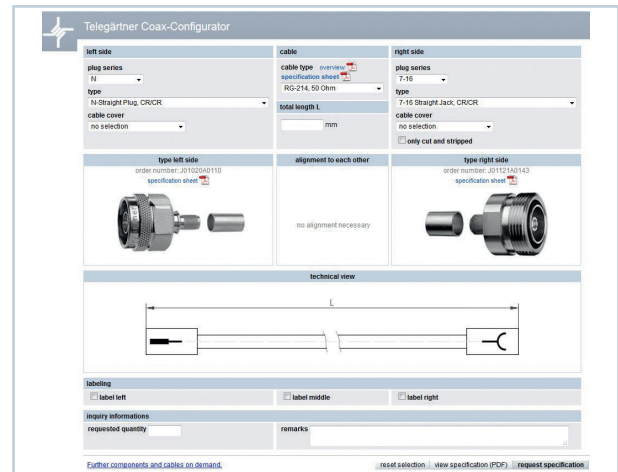

... and creation of a clear specification (PDF)

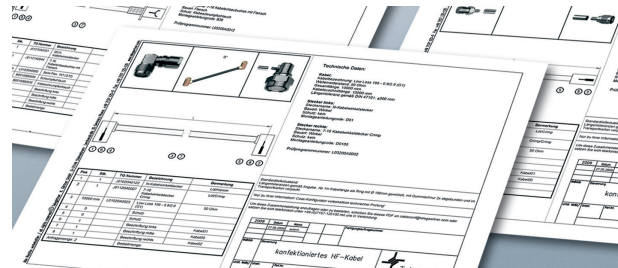

⇒ for individually assembled RF cables



you can find all the COAX products in the overview in our

COAX ONLINE CATALOGUE

www.telegaertner.com

Telegärtner
Karl Gärtner GmbH

Lerchenstr. 35
D-71144 Steinenbronn

Telefon: +49 (0) 71 57/1 25-0
Telefax: +49 (0) 71 57/1 25-5120

E-Mail: info@telegaertner.com
Web: www.telegaertner.com