



4K ULTRA **HD**

HDBaseT™ Extender

w/ RS-232, 2-way IR, and POH

EXT-UHDA-HBT2

User Manual



Release A2

Important Safety Instructions

1. Read these instructions.
2. Keep these instructions.
3. Heed all warnings.
4. Follow all instructions.
5. Do not use this product near water.
6. Clean only with a dry cloth.
7. Do not block any ventilation openings. Install in accordance with the manufacturer's instructions.
8. Do not install or place this product near any heat sources such as radiators, heat registers, stoves, or other apparatus (including amplifiers) that produce heat.
9. Do not defeat the safety purpose of the polarized or grounding-type plug. A polarized plug has two blades with one wider than the other. A grounding type plug has two blades and a third grounding prong. The wide blade or the third prong are provided for your safety. If the provided plug does not fit into your outlet, consult an electrician for replacement of the obsolete outlet.
10. Protect the power cord from being walked on or pinched particularly at plugs, convenience receptacles, and the point where they exit from the apparatus.
11. Only use attachments/accessories specified by the manufacturer.
12. To reduce the risk of electric shock and/or damage to this product, never handle or touch this unit or power cord if your hands are wet or damp. Do not expose this product to rain or moisture.
13. Unplug this apparatus during lightning storms or when unused for long periods of time.
14. Refer all servicing to qualified service personnel. Servicing is required when the apparatus has been damaged in any way, such as power-supply cord or plug is damaged, liquid has been spilled or objects have fallen into the apparatus, the apparatus has been exposed to rain or moisture, does not operate normally, or has been dropped.
15. Batteries that may be included with this product and/or accessories should never be exposed to open flame or excessive heat. Always dispose of used batteries according to the instructions.

Warranty Information

Gefen warrants the equipment it manufactures to be free from defects in material and workmanship.

If equipment fails because of such defects and Gefen is notified within two (2) years from the date of shipment, Gefen will, at its option, repair or replace the equipment, provided that the equipment has not been subjected to mechanical, electrical, or other abuse or modifications. Equipment that fails under conditions other than those covered will be repaired at the current price of parts and labor in effect at the time of repair. Such repairs are warranted for ninety (90) days from the day of reshipment to the Buyer.

This warranty is in lieu of all other warranties expressed or implied, including without limitation, any implied warranty or merchantability or fitness for any particular purpose, all of which are expressly disclaimed.

1. Proof of sale may be required in order to claim warranty.
2. Customers outside the US are responsible for shipping charges to and from Gefen.
3. Copper cables are limited to a 30 day warranty and cables must be in their original condition.

The information in this manual has been carefully checked and is believed to be accurate. However, Gefen assumes no responsibility for any inaccuracies that may be contained in this manual. In no event will Gefen be liable for direct, indirect, special, incidental, or consequential damages resulting from any defect or omission in this manual, even if advised of the possibility of such damages. The technical information contained herein regarding the features and specifications is subject to change without notice.

For the latest warranty coverage information, refer to the Warranty and Return Policy under the Support section of the Gefen Web site at www.gefen.com.

Technical Support

(707) 283-5900 (800) 472-5555
8:00 AM to 5:00 PM Monday - Friday, Pacific Time

Email

support@gefen.com

Web

<http://www.gefen.com>

Mailing Address

Gefen
Core Brands, LLC
c/o Customer Service
1800 S McDowell Blvd
Petaluma, CA 94954

Product Registration

Register your product here: <http://www.gefen.com/kvm/Registry/Registration.jsp>

Operating Notes

- The Gefen Syner-G™ Software Suite is a free downloadable application from Gefen that provides automatic download and installation of firmware upgrades as well as effortless configuration for this product.

Download the application here: <http://www.gefen.com/synerg/>

- This product is only compatible with Gefen Syner-G 2.1.x and later.

4K Ultra HD HDBaseT™ Extender w/ Ethernet, RS-232, 2-way IR, 2-way Audio, and Bidirectional POH
is a trademark of Gefen, LLC.

© 2016 Gefen, LLC. All Rights Reserved. All trademarks are the property of their respective owners.

Gefen, LLC reserves the right to make changes in the hardware, packaging, and any accompanying documentation without prior written notice.



This product uses UL listed or CE-compliant power supplies.

Features and Packing List

Features

- Extends HDMI, Ethernet, RS-232, 2-way IR, and 2-way Audio over a single CAT-5e
 - ▶ 4K Ultra HD (3840 x 2160 @ 60Hz, 4:2:0, 8-bit), up to 330 feet/100 meters
 - ▶ 4K Ultra HD (3840 x 2160 @ 30Hz, 4:4:4, 8-bit), up to 330 feet/100 meters
 - ▶ 4K DCI-Cinema (4096 x 2160 @ 30Hz 4:4:4, 8-bit), up to 330 feet/100 meters
 - ▶ 1080p Full HD (1920 x 1080 @ 60Hz, 4:4:4, 12-bit), up to 330 feet/100 meters
 - ▶ 1080p Full HD (1920 x 1080 @ 60Hz, 4:4:4, 8-bit), up to 495 feet/150 meters
 - ▶ WUXGA (1920 x 1200 @ 60Hz, 8-bit), up to 495 feet/150 meters
- HDMI Features Supported:
 - ▶ HDMI 2.0
 - ▶ HDCP 2.2 and 1.4
 - ▶ 12-bit Deep Color
 - ▶ LPCM 7.1 audio, Dolby Atmos®, Dolby® TrueHD, DTS:X™, and DTS-HD Master Audio™ pass-through
 - ▶ 3DTV pass-through
 - ▶ CEC pass-through
 - ▶ Lip Sync pass-through
- IR extension from Sender to Receiver and from Receiver to Sender
- TOSLINK® Optical Digital Audio extension from Receiver to Sender
- Analog L/R Stereo Audio extension from Sender to Receiver
- Bi-Directional POH (Power Over HDBaseT™) feature provides power to the Sender or the Receiver unit over the link cable - only one side needs external power
- Advanced EDID Management via Gefen Syner-G™ software
- Link Quality Monitoring via Gefen Syner-G™ software
- Firmware upgradable via USB, using Gefen Syner-G™ software
- Locking power connector
- Low profile, surface-mountable enclosures



Packing List

The 4K Ultra HD HDBaseT™ Extender w/ Ethernet, RS-232, 2-way IR, 2-way Audio, and Bidirectional POH ships with the items listed below. The packing contents of the Sender and Receiver unit are listed below. If any of these items are not present in the box when you first open it, immediately contact your dealer or Gefen.

- 1 x 4K Ultra HD HDBaseT™ Extender w/ Ethernet, RS-232, 2-way IR, 2-way Audio, and Bidirectional POH (Sender)
- 1 x 4K Ultra HD HDBaseT™ Extender w/ Ethernet, RS-232, 2-way IR, 2-way Audio, and Bidirectional POH (Receiver)
- 1 x IR emitter
- 1 x IR extender
- 1 x DB-9 cable (M-F)
- 1 x 48V DC locking power supply
- 1 x Quick-Start Guide

1 Getting Started

Introduction.....	2
Sender Unit	2
Receiver Unit.....	4
Installation	6
Connection Instructions.....	6
Application Diagram	7

2 Basic Operation

DIP Switch Configuration	10
Sender unit.....	10
Receiver unit.....	12
Notes on IR Carrier Signals	14
LED Status	15
Two-way IR Control.....	16
Controlling the Source from the Viewing Location	16
Controlling the Display from the Source Location.....	17
Controlling the Source / Display from Different Locations.....	18
RS-232 Interface	19
RS-232 Interface	19

3 Advanced Operation

Using Syner-G™	24
Verifying the USB Driver	24
Downloading an EDID.....	26
Uploading an EDID	29
Copying an EDID	31
Viewing an EDID	33
Link Quality Monitoring.....	37

4 Appendix

Updating the Firmware	46
Default Settings.....	52
Sender unit default settings.....	52
Receiver unit default settings	52
Network Cable Diagram	53
Specifications	54
Index.....	56

This page left intentionally blank.

This page left intentionally blank.

4K ULTRA  **HD**

HDBaseT™ Extender

w/ Ethernet, RS-232, 2-way IR, 2-way Audio, and Bidirectional POH

1

Getting Started

Sender Unit

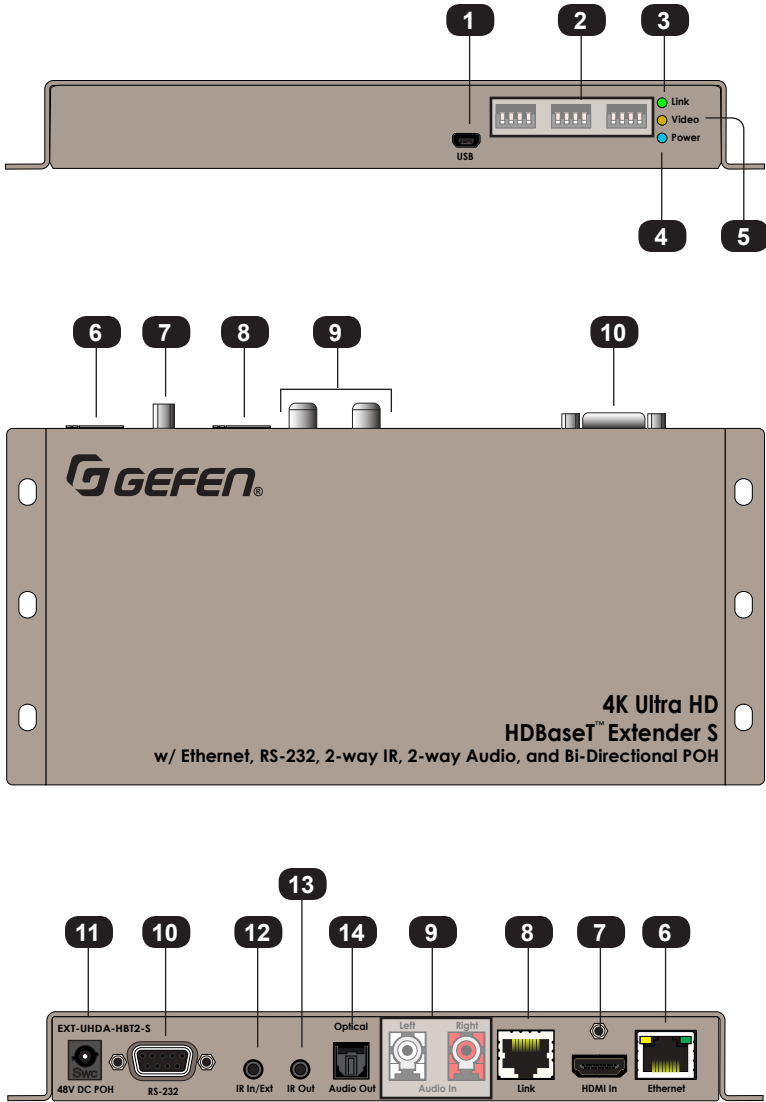

ID	Name	Description
1	USB	For use with the Syner-G Software Suite. See Using Syner-G™ (page 24) for more information.
2	DIP switches	See DIP Switch Configuration (page 10) for more information.
3	Link	This LED indicator glows solid green when the Sender and Receiver unit are connected by a CAT-5 (or better) cable.
4	Power	This LED indicator glows solid blue when the Sender unit is powered.
5	Video	This LED indicator glows solid amber when a video source is connected to the Sender unit.
6	Ethernet	This port is used to extend a network device. Connect a CAT-5 (or better) cable from this port to the LAN.
7	HDMI In	Connect a 4K Ultra HD source to this HDMI port using an HDMI cable.
8	Link	Connect a CAT-5 (or better) cable from this port to the Link port on the Receiver unit.
9	Audio In (Left / Right)	Use L/R RCA audio cables to connect an analog audio source to these jacks.
10	RS-232	Connect the included RS-232 cable from this port to an automation device. See RS-232 Interface (page 19) for more information.
11	POH 48V DC	Connect the included 48V DC power supply to this connector.
12	IR In / Ext	Connect an IR extender (Gefen part no. EXT-RMT-EXTIRN) to this port.
13	IR Out	Connect an IR emitter (Gefen part no. EXT-2IREMIT) to this port.
14	Optical (Audio Out)	Connect an optical audio cable from this TOSLINK port to an A/V receiver.

Receiver Unit

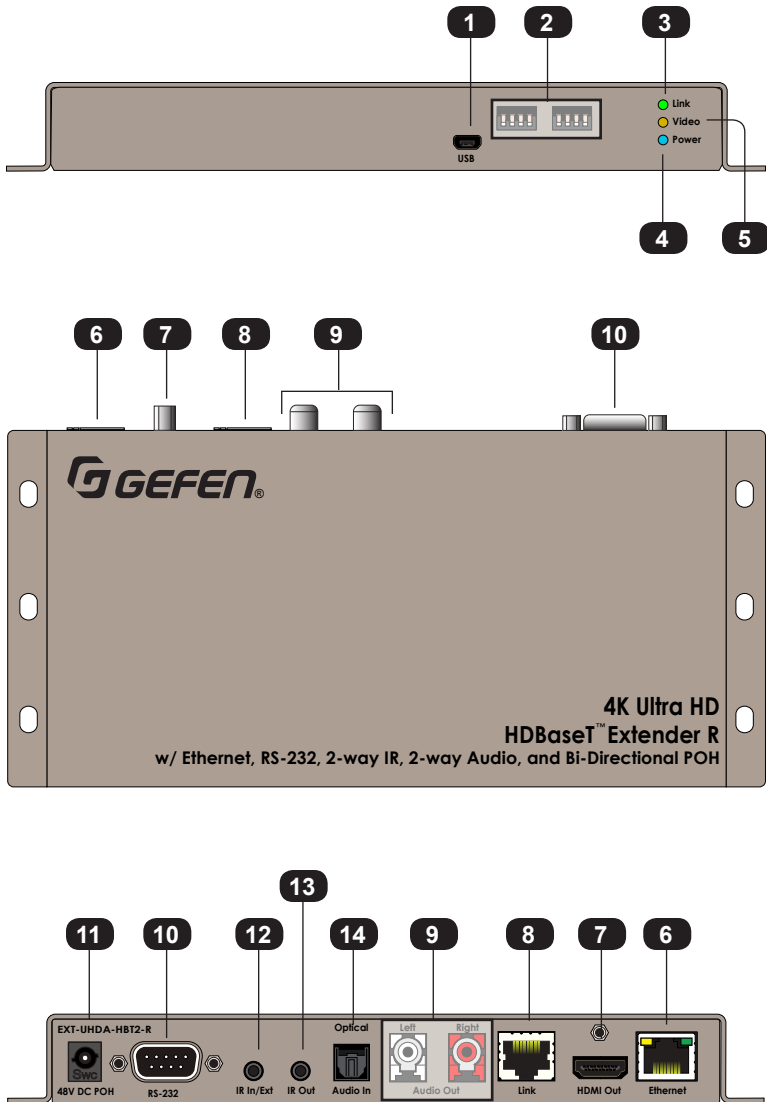

ID	Name	Description
1	USB	For use with the Syner-G Software Suite. See Using Syner-G™ (page 24) for more information.
2	DIP switches	See DIP Switch Configuration (page 10) for more information.
3	Link	This LED indicator glows solid green when the Sender and Receiver unit are connected by a CAT-5 (or better) cable.
4	Power	This LED indicator glows solid blue when the Sender unit is powered.
5	Video	This LED indicator glows solid amber when a video source is connected to the Sender unit.
6	Ethernet	This port is used to extend a network device. Connect a CAT-5 (or better) cable from this port to the network device.
7	HDMI Out	Connect a 4K Ultra HD display to this HDMI port using an HDMI cable
8	Link	Connect a CAT-5 (or better) cable from this port to the Link port on the Sender unit.
9	Audio Out (Left / Right)	Use L/R RCA audio cables to connect an audio sink device to these jacks.
10	RS-232	Connect the included RS-232 cable from this port to an RS-232 device. See RS-232 Interface (page 19) for more information.
11	POH 48V DC	This power connector is not used.
12	IR In / Ext	Connect an IR extender (Gefen part no. EXT-RMT-EXTIRN) to this port.
13	IR Out	Connect an IR emitter (Gefen part no. EXT-2IREMIT) to this port.
14	Optical (Audio In)	Connect an optical audio cable from the sink device to this TOSLINK port.

Connection Instructions

▶ Video

1. Connect the included HDMI cable from the 4K Ultra HD source device to the **HDMI In** port on the Sender unit.
2. Connect an HDMI cable from the **HDMI Out** port on the Receiver unit to a 4K Ultra HD display.

▶ Audio

3. Connect a stereo RCA cable from an analog audio source to the **Audio In** ports on the Sender unit.
4. Connect a stereo RCA cable from the **Audio Out** ports on the Receiver unit to an A/V receiver.
5. Connect an optical audio cable from the 4K Ultra HD display to the **Optical Audio In** TOSLINK port on the Receiver unit.
6. Connect an optical audio cable from the **Optical Audio Out** TOSLINK port on the Sender unit to an A/V receiver.

▶ Link

7. Connect a shielded CAT-5 (or better) cable from the **Link** port on the Sender unit to the **Link** port on the Receiver unit.

Maximum Resolution	Mode	Distance
1920 x 1080p 60 Hz @ 8-bit	Long Reach mode	495 feet (150 meters)
3840 x 2160p 60 Hz @ 4:2:0	Normal mode	330 feet (100 meters)

See [DIP Switch Configuration \(page 10\)](#) for more information on setting the extension distance.

▶ Ethernet

8. Connect a CAT-5 (or better) cable from the LAN to the **Ethernet** port on the Sender unit.
9. Connect a CAT-5 (or better) cable from the **Ethernet** port on the Receiver unit to a network device.

► **RS-232 Control** (Optional)

For more information see [RS-232 Interface](#) (page 19).

10. Connect the included DB-9 cable from the **RS-232** port on the Sender unit to the automation control device.
11. Connect a DB-9 cable from the **RS-232** port on the Receiver unit to the RS-232 device to be controlled.

► **IR Control** (Optional)

For more information see [Two-way IR Control](#) (page 16).

12. Connect the included IR emitter to the **IR Out** port on the Sender unit.
13. Connect the included IR extender to the **IR In/Ext** port on the Receiver unit.

► **Power**

14. Connect the included power supply to the **POH 48V DC** connector on either the Sender or Receiver unit. Power is supplied to the other unit over the **Link** connector.
15. Connect the power supply to an available electrical outlet.

Application Diagram

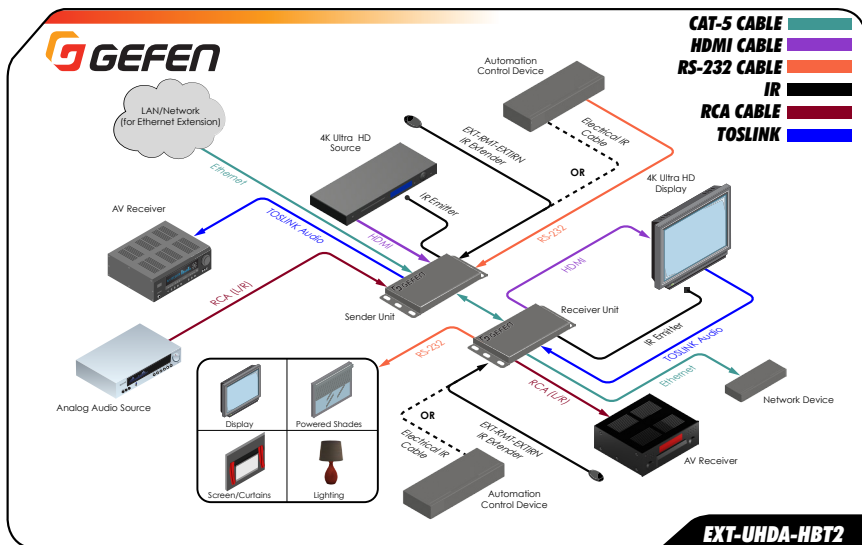

This page left intentionally blank.

4K ULTRA 

HDBaseT™ Extender

w/ Ethernet, RS-232, 2-way IR, 2-way Audio, and Bidirectional POH

2 Basic Operation

Sender unit

The back panel of the Sender unit contains three banks of DIP switches. Each bank contains four DIP switches. These DIP switches control EDID, HPD, HDCP, IR, and HDBT mode. The *default* setting, for each DIP switch, is in the “down” (OFF) position.

Each DIP switch (1 - 12) is arranged from left to right. DIP switches 11 and 12 are not used. Although the DIP switch numbers do not appear on the unit, we have included them for easy reference.

If a DIP switch is in the “up” position, then it is ON. If a DIP switch is in the “down” position, then it is OFF.

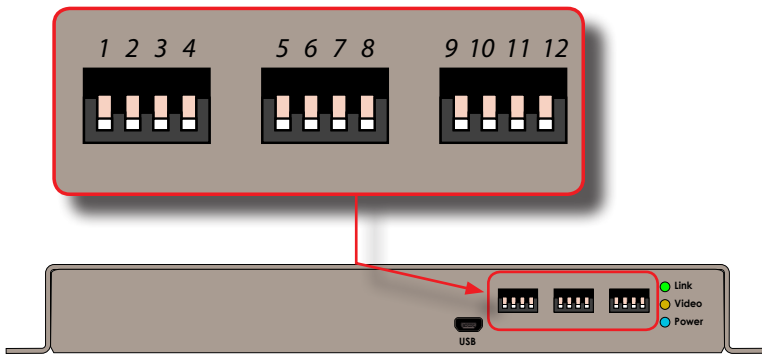

DIP	Feature	Description
1	Local / pass-through EDID	<ul style="list-style-type: none"> ▶ ON Allows all video and audio features of the connected device to be passed to the source device. ▶ OFF (default) Copies the downstream EDID locally in HDBT mode; modifies downstream EDID to support only up to 1080p60 8-bit in Long Reach mode.
2	HPD Control	<ul style="list-style-type: none"> ▶ ON HPD will toggle, depending upon the HPD status of the display (sink) or source device. ▶ OFF (default) HPD remains high, even when the display is hot-plugged (disconnected then reconnected to the source device).

DIP	Feature	Description
3	Local / pass-through EDID	<ul style="list-style-type: none"> ▶ ON EDID Lock <i>enabled</i>. The current (downstream) EDID will be stored on the input even if the unit is power-cycled. ▶ OFF (default) EDID Lock <i>disabled</i>.
4	HDCP Control	<ul style="list-style-type: none"> ▶ ON Prevents HDCP content from passing through to the display (sink) device. ▶ OFF (default) Allows HDCP content to pass through to the display (sink) device.
5	Sender IR carrier filter	<ul style="list-style-type: none"> ▶ ON IR carrier signal is stripped at the Sender unit. ▶ OFF (default) IR carrier signal is passed-through.
6	Receiver IR carrier filter	<ul style="list-style-type: none"> ▶ ON IR carrier signal is stripped at the Receiver unit. ▶ OFF (default) IR carrier signal is passed-through.
7	IR Polarity	<ul style="list-style-type: none"> ▶ ON Set to work with third-party IR extenders. ▶ OFF (default) Operates with Gefen part no. EXT-RMT-EXTIRN.
8	Long-Reach Mode	<ul style="list-style-type: none"> ▶ ON Resolutions up to 1080p Full HD can be extended to a maximum distance of 495 feet (150 meters). Color depth is limited to 8-bit. ▶ OFF (default) HDBT mode. Resolutions up to 4K x 2K, can be extended up to 330 feet (100 meters) with deep color.

DIP	Feature	Description
9	IR Carrier Frequency	<ul style="list-style-type: none"> ▶ ON 56 kHz. ▶ OFF (default) 38 kHz.
10	IR Carrier Frequency	<ul style="list-style-type: none"> ▶ ON 47 kHz. ▶ OFF (default) Depends upon setting of DIP 9.
11	N/A	---
12	N/A	---

Receiver unit

The back panel of the Receiver unit contains two banks of DIP switches. Each bank contains four DIP switches. These DIP switches control IR and HDBT mode. The *default* setting, for each DIP switch, is in the “down” (OFF) position.

Each DIP switch (1 - 8) is arranged from left to right. DIP switches 7 and 8 are not used. Although the DIP switch numbers do not appear on the unit, we have included them for easy reference.

If a DIP switch is in the “up” position, then it is ON. If a DIP switch is in the “down” position, then it is OFF.

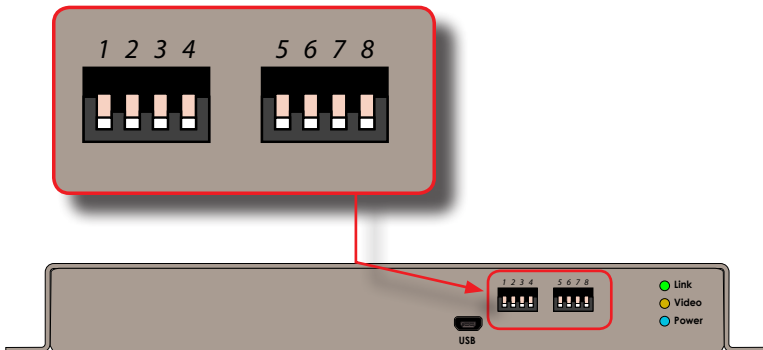

DIP	Feature	Description
1	Sender IR carrier filter	<ul style="list-style-type: none"> ▶ ON The IR carrier signal is stripped at the Sender unit. ▶ OFF (default) The IR carrier signal is passed-through to the Receiver unit.
2	Receiver IR carrier filter	<ul style="list-style-type: none"> ▶ ON The IR carrier signal is stripped at the Receiver unit. ▶ OFF (default) The IR carrier signal is passed-through to the Sender unit.
3	IR Polarity	<ul style="list-style-type: none"> ▶ ON Set to work with third-party IR extenders. ▶ OFF (default) Operates with Gefen part no. EXT-RMT-EXTIRN.
4	Long-Reach Mode	<ul style="list-style-type: none"> ▶ ON Resolutions up to 1080p Full HD can be extended to a maximum distance of 495 feet (150 meters). Color depth is limited to 8-bit. ▶ OFF (default) HDBT mode. Resolutions up to 4K x 2K, can be extended up to 330 feet (100 meters) with deep color.
5	IR carrier frequency	<ul style="list-style-type: none"> ▶ ON 56 kHz. ▶ OFF (default) 38 kHz.
6	IR carrier frequency	<ul style="list-style-type: none"> ▶ ON 47 kHz. ▶ OFF (default) Depends upon setting of DIP 5.
7	N/A	---
8	N/A	---

Notes on IR Carrier Signals

When an IR carrier frequency is passed through from the Sender unit to the Receiver unit, or from the Receiver unit to the Sender unit, the carrier signal is not renewed. Any carrier frequency between 30 kHz and 60 kHz is natively passed through.





If the IR carrier signal is stripped at the Sender unit and added at the Receiver unit (or vice versa), then the carrier signal can be set to 38 kHz, 47 kHz, or 56 kHz.

To set the carrier signal frequency on the Sender unit, use DIP switches 9 and 10 on the Sender unit. To set the carrier signal frequency on the Receiver unit, use DIP switches 5 and 6 on the Receiver unit.

Stripping the IR carrier signal is commonly used when directly connecting an IR cable from the output of one device to the input on another IR device.

The **Link, Video, and Power** LED indicators provides basic information on the current status of the this product.

The information, in the table below, applies to both the Sender and Receiver unit.

LED	Status	Description
Link	 Solid green	<ul style="list-style-type: none">The Sender / Receiver unit is powered.Link integrity between Sender and Receiver unit is good.
	 Flashing amber	<ul style="list-style-type: none">Non-HDCP content is detected.
Video	 Solid amber	<ul style="list-style-type: none">HDCP content is detected
	 Flashing amber	<ul style="list-style-type: none">Non-HDCP content is detected.
Power	 Solid blue	<ul style="list-style-type: none">The Sender / Receiver unit is powered.

Controlling the Source from the Viewing Location

1. Connect an IR extender (Gefen part no. EXT-RMT-EXTIRN) to the **IR In/Ext** port on the Receiver unit. If using an automation system, connect the 3.5mm mini-mono connector from the **IR In/Ext** port on the Receiver unit to the automation system. IR signals are transmitted over the CAT-5 cable.
2. Connect the IR emitter from the **IR Out** port, on the Sender unit, to the IR sensor window on the source device.

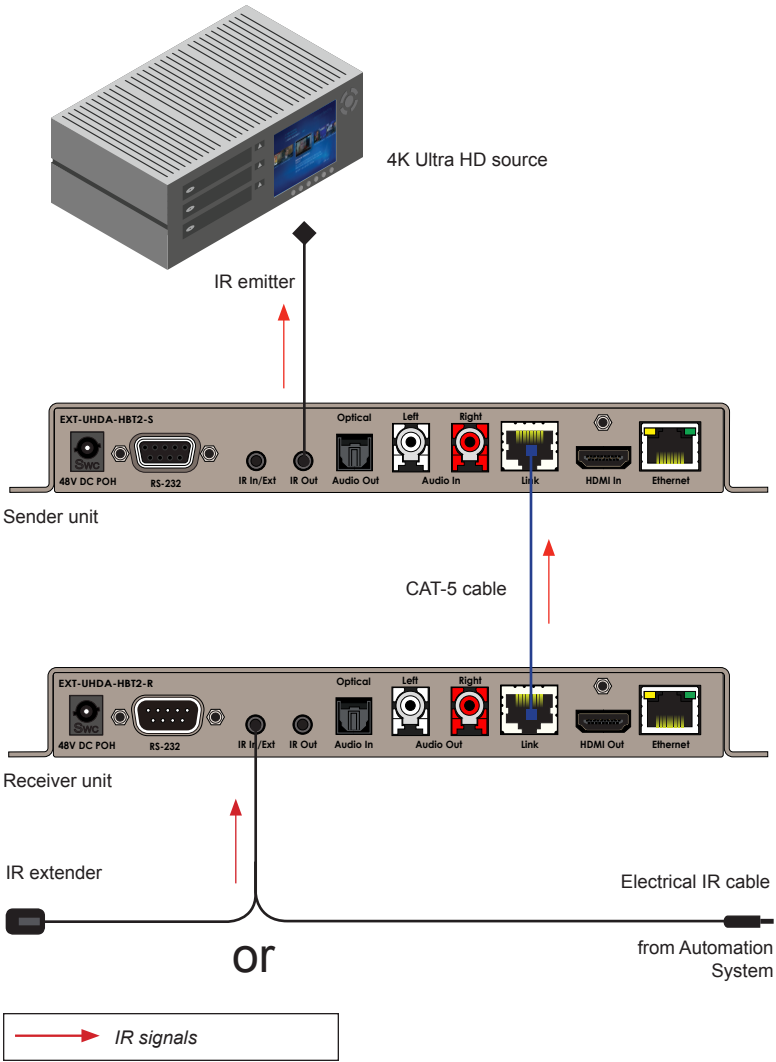

Controlling the Display from the Source Location

1. Connect an IR extender (Gefen part no. EXT-RMT-EXTIRN) to the **IR In/Ext** port on the Sender unit. If using an automation system, connect the 3.5mm mini-mono connector from the **IR In/Ext** port on the Receiver unit to the automation system. IR signals are transmitted over the CAT-5 cable.
2. Connect an IR emitter (Gefen part no. EXT-IREMIT) from the **IR Out** port on the Receiver unit to the IR sensor on the display.

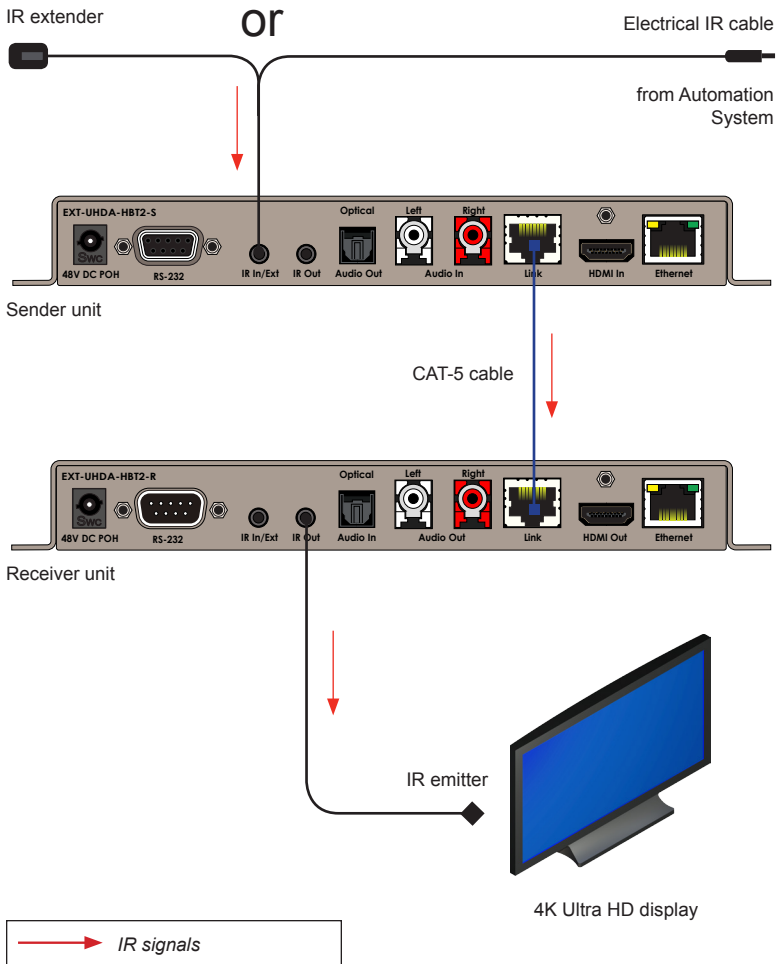

Controlling the Source / Display from Different Locations

Two-way IR allows the source and/or display to be controlled from the Sender or Receiver unit. Refer to the diagram, below, for connection details. IR signals are transmitted over the CAT-5 cable.

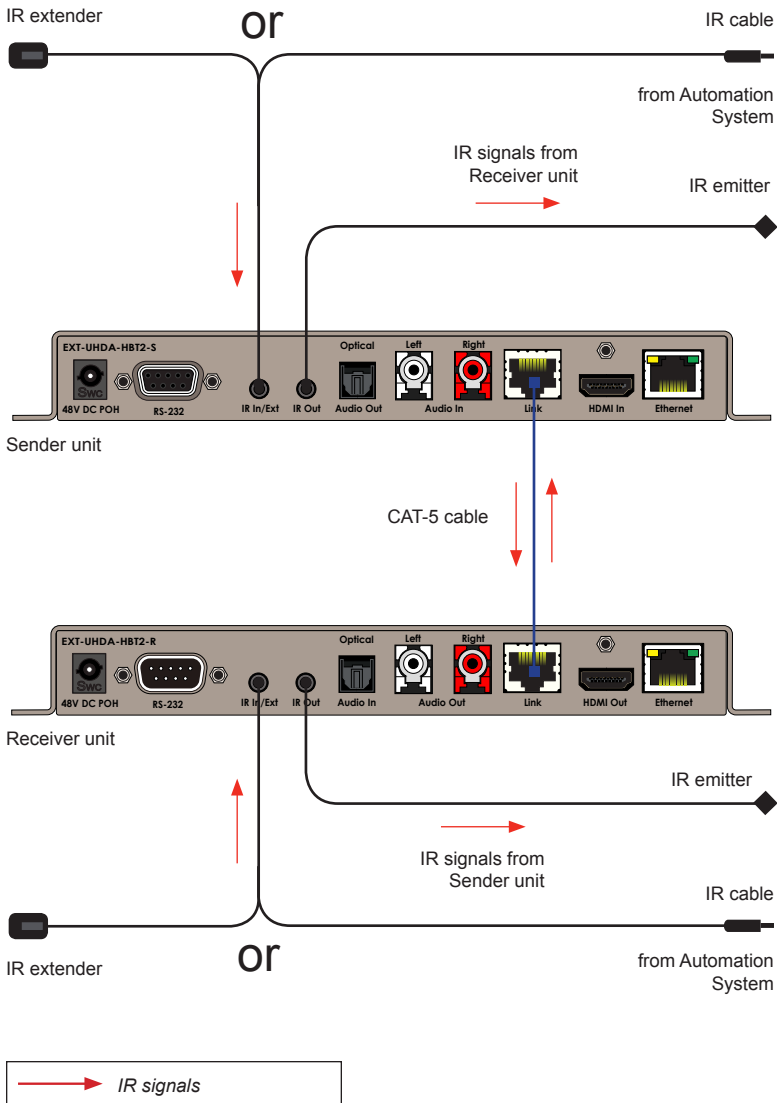

RS-232 Interface

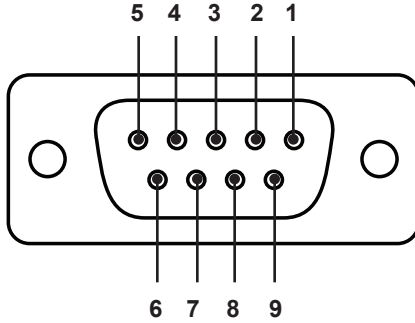

Automation Device

Extender

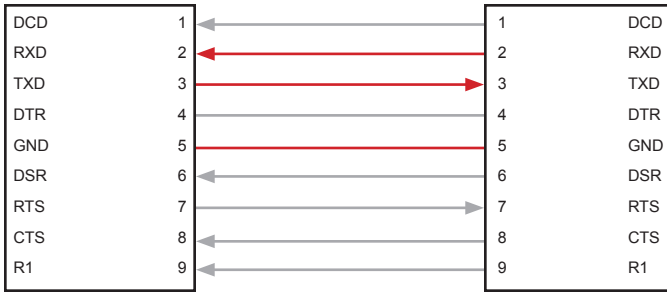

Only TXD, RXD, and GND pins are used.

This product supports RS-232 pass-through, allowing the control of remote RS-232 devices.

In the example below, an RS-232 device has been connected to the Receiver unit. Connect the automation control device to the Sender unit.

Figure 2.1 - Basic RS-232 connection

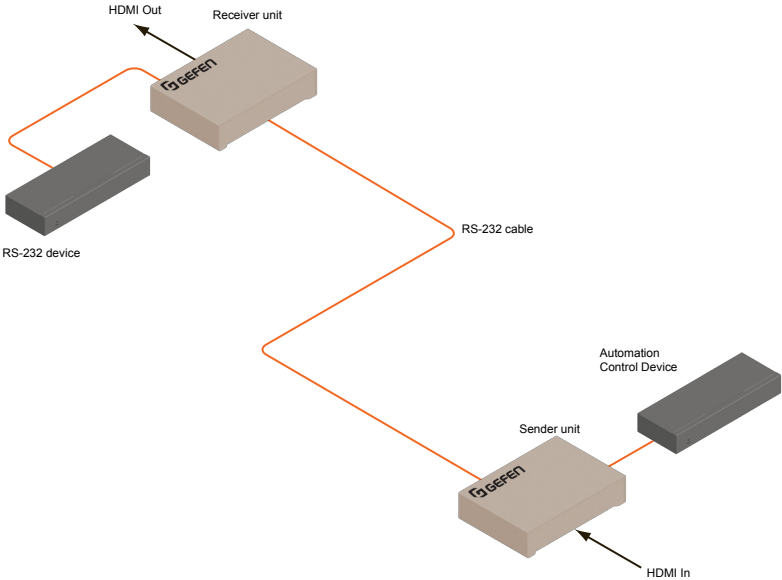

This page left intentionally blank.

This page left intentionally blank.

4K ULTRA 

HDBaseT™ Extender

w/ Ethernet, RS-232, 2-way IR, 2-way Audio, and Bidirectional POH

3

Advanced Operation

Verifying the USB Driver

In order to use this product with the Gefen Syner-G™ software, a USB driver must be installed on the computer that is running the Syner-G™ software. This driver is automatically installed when the Syner-G™ Software Suite is installed.

1. Download and install the Gefen Syner-G™ Software Suite. The Syner-G™ software can be downloaded here: <http://www.gefen.com/synerg>.
2. Connect a mini-USB-to-USB cable (not included) from the **USB** port on the front of the Sender or Receiver unit to an available USB port on the computer.
3. From the Windows Desktop, click the **Start** button, select **Computer**, then right-click and select **Manage** from the context menu.

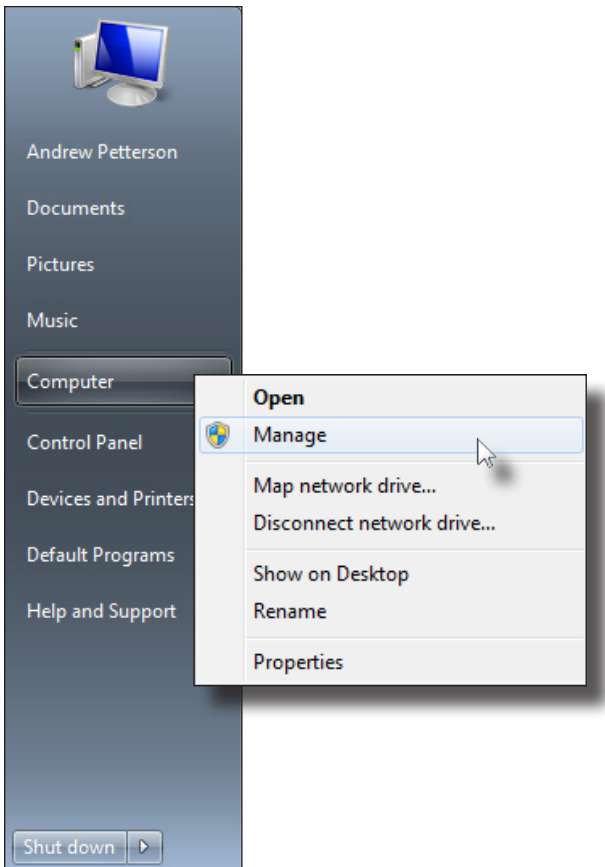

4. The **Computer Management** window will open.
5. In the left window pane, under **System Tools**, click **Device Manager**.
6. In the right window pane, locate **Ports (COM & LPT)**.

The device driver will be displayed. In this case, **EXT-UHDA-HBT2-S** will be displayed. If the USB cable is connected to the Receiver unit, then the device driver will be **EXT-UHDA-HBT2-R**.

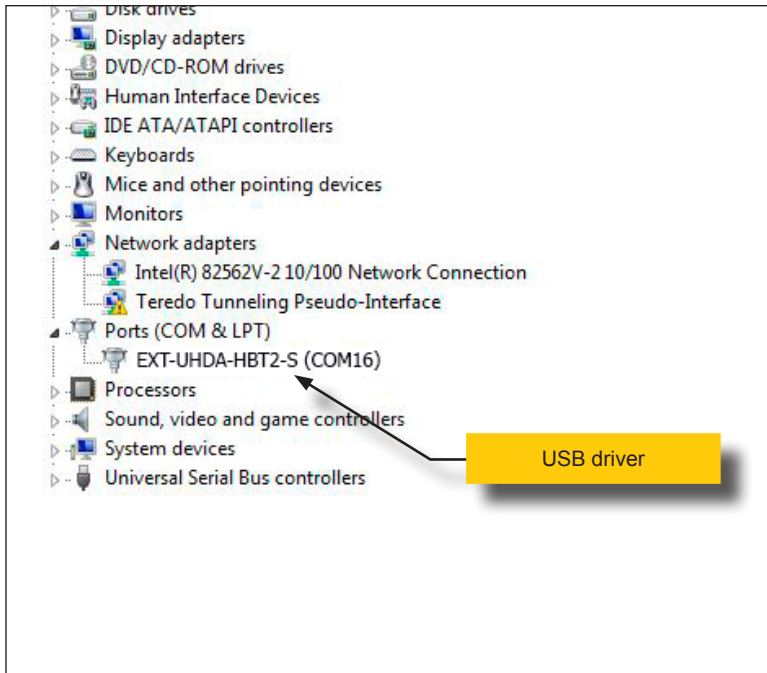

Downloading an EDID

EDID data can be downloaded from the connected Gefen Detective device to a local file. Note that the Downstream EDID or Bank EDID data cannot be downloaded to a file. To download this EDID data, it must first be copied to the Local EDID. See [Copying an EDID \(page 31\)](#) for more information on copying EDID data.

1. Click the **Manage a Product** button and select the connected product from the drop-down list.
2. Click the **Manage EDID** tab.

The screenshot shows the 'Manage EDID' interface. At the top, the 'Select Function' bar contains three buttons: 'Discover and Configure IP', 'Manage a Product', and 'EDID Editor'. Below this, the 'Select Product' dropdown menu is set to 'EXT-UHDA-HBT2-S, COM16'. The 'Manage EDID' tab is selected, showing a 'Version Info' box with the following text: 'EXT_UHDA_HBT2_S', 'Release version: 1.00', 'Release date: Nov 2 2015', and 'Release time: 13:06:29'. Below the version info, there is a 'Select EDID From Device' dropdown menu, a 'Save As' button, and a 'View' button. A red box highlights the 'Upload EDID to' and 'Copy EDID from' sections. The 'Upload EDID to' section has a dropdown menu set to 'Local EDID', a text input field, a 'Browse' button, and an 'Upload' button. The 'Copy EDID from' section has a dropdown menu set to 'Down Stream', a 'to' label, a dropdown menu set to 'Local EDID', and a 'Copy' button. At the bottom, the 'EDID Mode' section has two buttons: 'Internal' and 'Custom'.

- Information about the currently selected device will be displayed in the **Version Info** field.

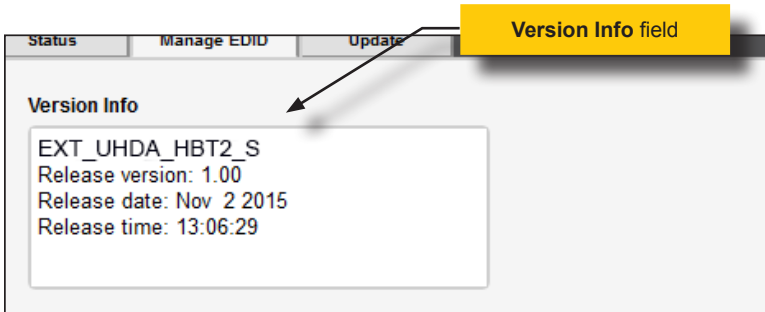

- Click the drop-down list next to the **Download** button, and select the desired EDID. In this example, we will select `Extender: Local EDID`.

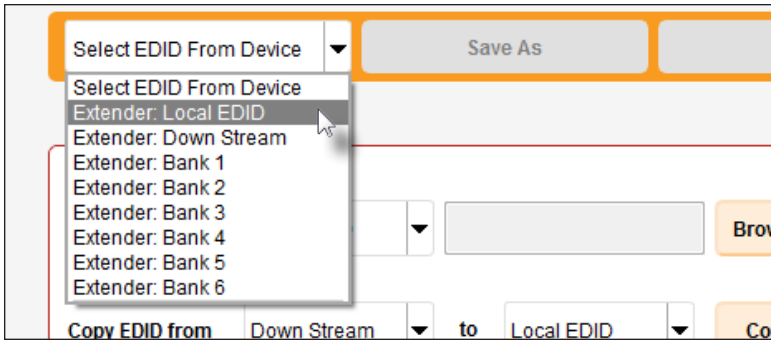

- Click the **Save As** button.



- The Windows **Save File** dialog will be displayed. Select the desired folder and specify the name of the file in the **File name** field, within the **Save File** dialog. Make sure to specify the `.bin` extension to the filename.

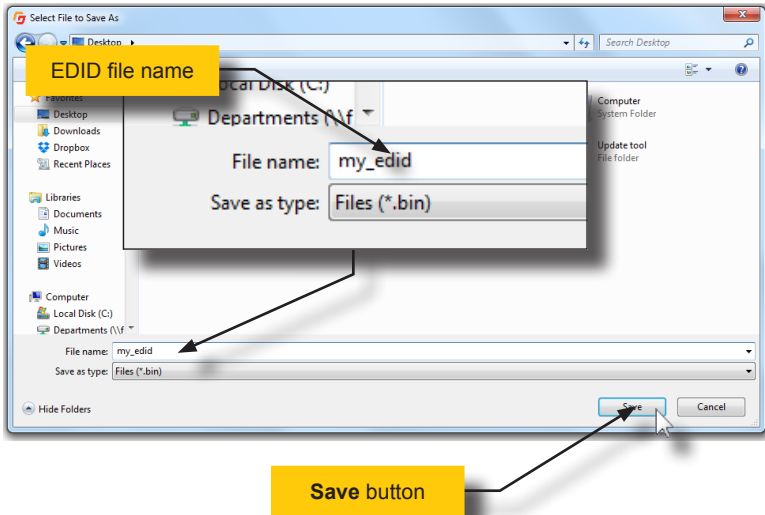

7. Click the **Save** button.

Uploading an EDID

1. Click the **Manage a Product** button and select the connected product from the drop-down list.
2. Click the **Manage EDID** tab.
3. Click the **Upload EDID to** drop-down list to select the location where the EDID will be uploaded. The EDID can be uploaded to the Local EDID or an EDID bank.

In the example below, we will select **Local EDID**.

The screenshot shows a web interface for managing EDID. At the top, there is a dropdown menu labeled "Select EDID From Device" with a downward arrow, followed by "Save As" and "View" buttons. Below this, there is a section for uploading and copying EDID. The "Upload EDID to" dropdown menu is open, showing options: "Local EDID", "Bank 1", "Bank 2", "Bank 3", "Bank 4", "Bank 5", and "Bank 6". A mouse cursor is pointing at "Local EDID". To the right of this dropdown is a text input field and a "Browse" button. Below the "Upload EDID to" section, there is a "Copy EDID from" dropdown menu with options "Local EDID", "Bank 1", "Bank 2", "Bank 3", "Bank 4", "Bank 5", and "Bank 6". A mouse cursor is pointing at "Local EDID". To the right of this dropdown is a "to" label, another dropdown menu with "Local EDID" selected, and a "Copy" button.

4. Click the **Browse** button.

The screenshot shows the same web interface as the previous one. The "Upload EDID to" dropdown menu is now closed and set to "Local EDID". The "Copy EDID from" dropdown menu is also closed and set to "Down Stream". The "Browse" button is highlighted with a mouse cursor, indicating it is being clicked. The "Copy" button is also visible.

- The Windows **Select File** dialog will be displayed.
- Select the desired EDID file. The EDID file must be in `.bin` format.
- Click the **Open** button.

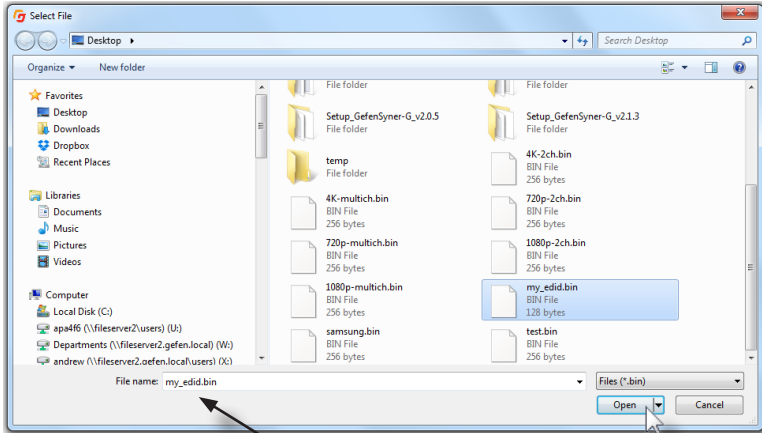

File name: `my_edid.bin`

- Click the **Upload** button.

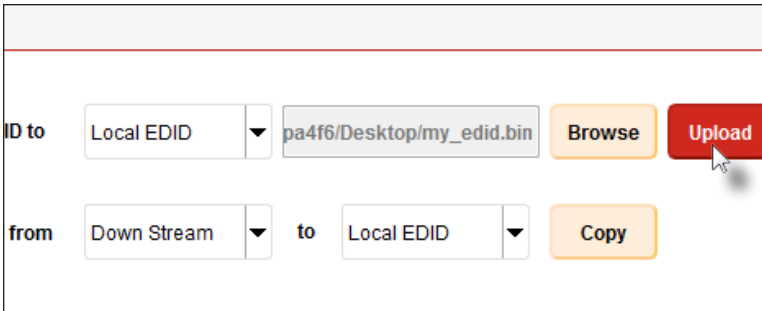

- In the lower-left corner of the interface, the “Uploading...” message will appear as the EDID is uploaded. Once the operation is complete, the “Upload Complete.” message will be displayed.

Uploading...

Upload Complete.

Copying an EDID

1. Click the **Manage a Product** button and select the connected product from the drop-down list.
2. Click the **Manage EDID** tab.
3. Click the **Copy EDID from** drop-down list to select the location from where the EDID will be copied. The EDID can be copied from any of the following locations: The downstream EDID, an EDID bank, or a default EDID location

In the example below, we will select **Down Stream**.

The screenshot shows a web interface for managing EDID. It features three main sections:

- Upload EDID to:** A dropdown menu set to 'Local EDID' with a 'Browse' button to its right.
- Copy EDID from:** A dropdown menu currently open, showing a list of options: 'Down Stream', 'Bank 1', 'Bank 2', 'Bank 3', 'Bank 4', 'Bank 5', 'Bank 6', 'Default EDID 1', 'Default EDID 2', and 'Default EDID 3'. A mouse cursor is pointing at 'Down Stream'.
- to:** A dropdown menu set to 'Local EDID' with a 'Copy' button to its right.
- EDID Mode:** A section with a 'Custom' button.

4. Click the **Copy EDID to** drop-down list to select the location to where the EDID will be copied. The EDID can be copied to the Local EDID or to an EDID bank.

This screenshot shows the same interface as the previous one, but with the 'Copy EDID to' dropdown menu open. The menu options are 'Local EDID', 'Bank 1', 'Bank 2', 'Bank 3', 'Bank 4', 'Bank 5', and 'Bank 6'. A mouse cursor is pointing at 'Local EDID'. The 'Copy EDID from' dropdown is now closed and set to 'Down Stream'. The 'EDID Mode' section now shows an 'Internal' button instead of 'Custom'.

- Click the **Copy** button.

Upload EDID to: Local EDID [dropdown] [input field] [Browse]

Copy EDID from: Down Stream [dropdown] to: Local EDID [dropdown] [Copy]

EDID Mode: [Internal] [Custom]

- In the lower-left corner of the interface, the “Copying...” message will appear as the EDID is uploaded. The copy-result message will vary, depending upon the copy operation.



In this example, since we copied the downstream EDID to the local EDID, the “Copy result: Downstream stored to local.” message is displayed.

Viewing an EDID

1. Click the **Manage a Product** button and select the connected product from the drop-down list.
2. Click the **Manage EDID** tab.

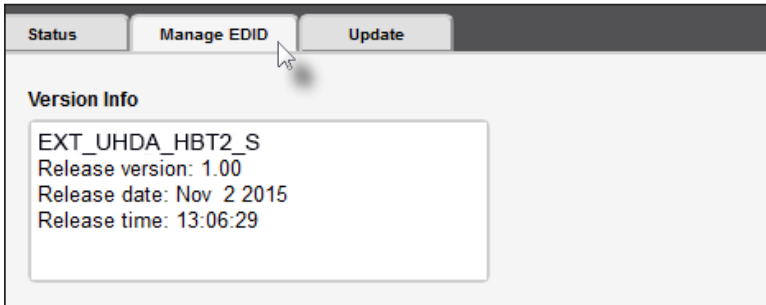

3. Click the **Select EDID From Device / Display** drop-down list to select the desired EDID.

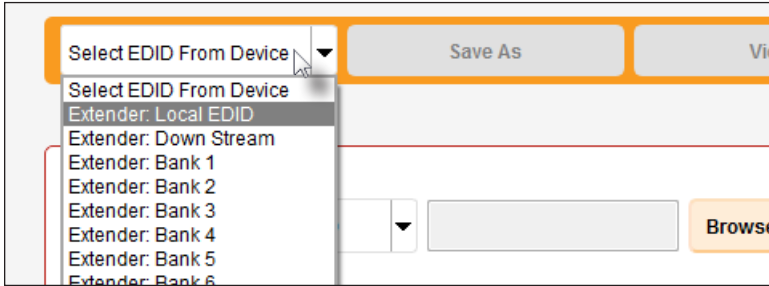

Note that the display, which is connected to the computer, is also available in the drop-down list. In this way, we can download, view, and/or edit the EDID from the display (sink) device.

4. Click the **View** button.



- After a few seconds, Syner-G will also switch to the **EDID Editor** screen. See the Gefen Syner-G™ User Manual for more information on using the EDID Editor.
- Click the desired EDID tab to view specified information on the EDID. Note that some sections within a tab use scroll bars to indicate that more information is available.

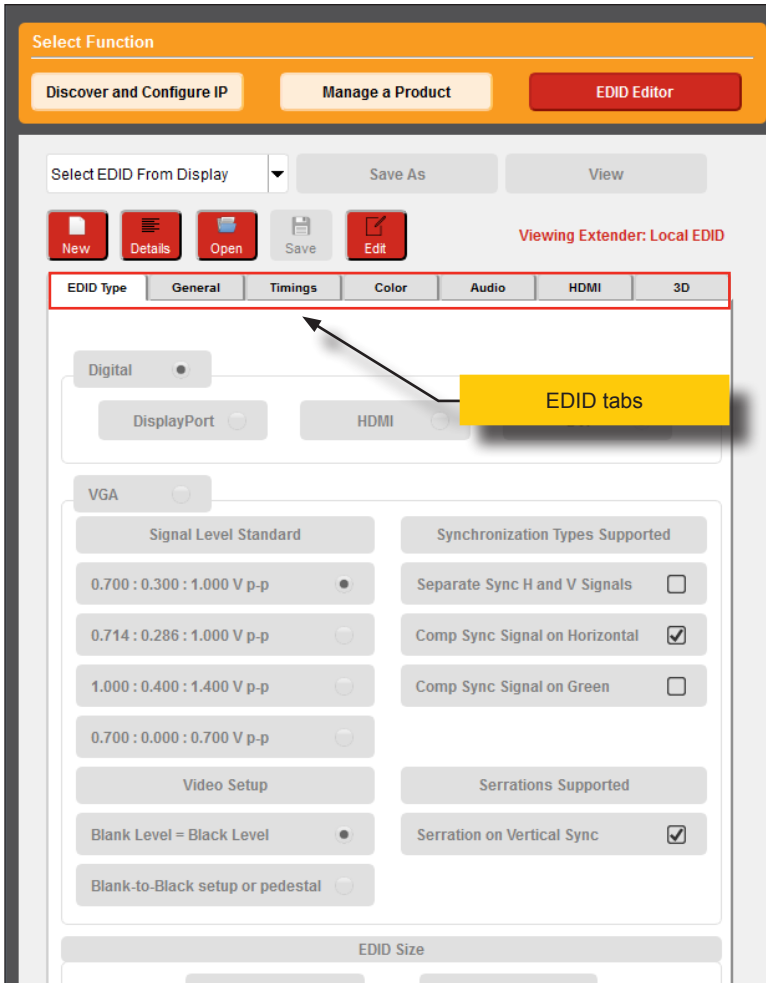

Information

Video cards which use Intel® chipsets will only retrieve the first block (128 bytes) of the EDID.

- Click the **Details** button.

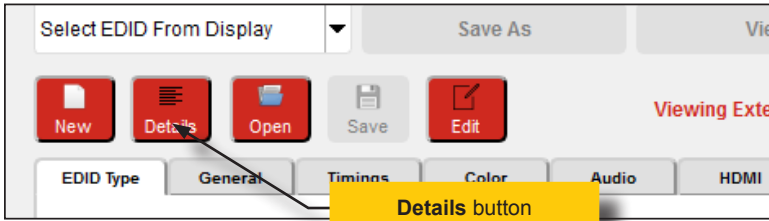

- The **EDID Summary** window will be displayed. Use the horizontal and vertical scroll bar, as needed, to view the EDID information.

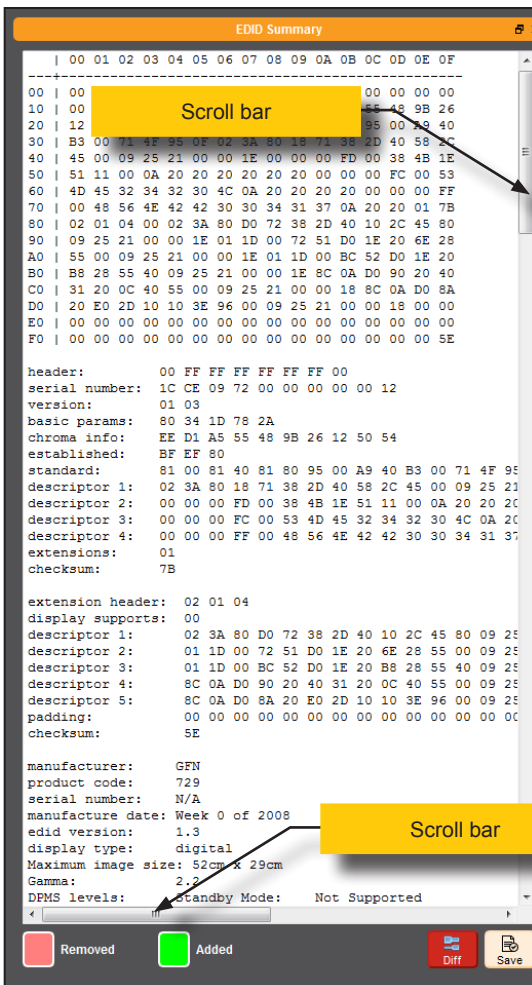

- Click the  button, in the upper-right corner of the **EDID Summary** window to separate the **EDID Summary** window from the main Syner-G window:

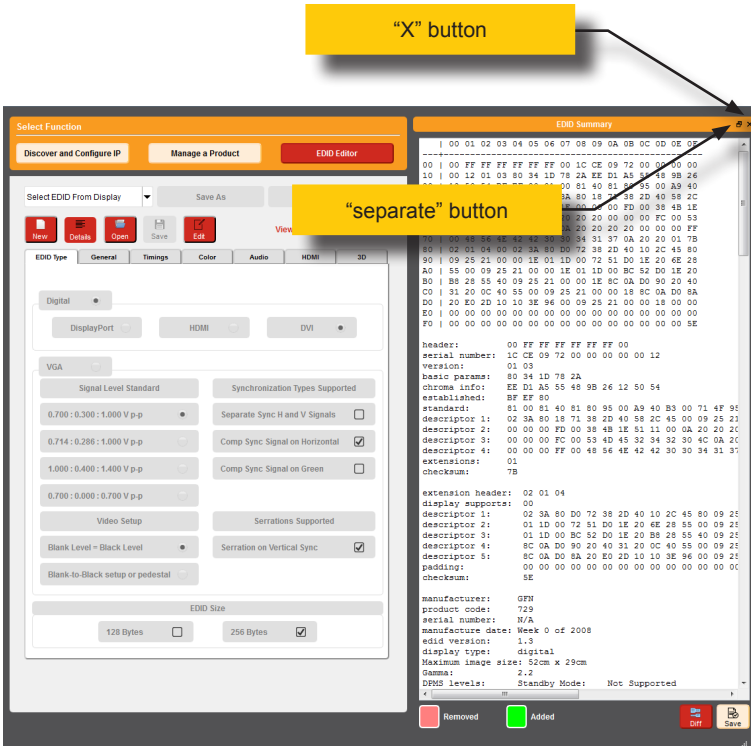

- Double-click the window title bar of the detached EDID Summary window to reattach it to the main window. it to the main Syner-G window.
- To close the **EDID Summary** window, either click the **X** button, in the upper-right corner of the **EDID Summary** window or click the **Details** button in the main Syner-G window.

Link Quality Monitoring

The **Status** tab provides information about signal quality in HDBaseT installations. This page will only be available when connected to a Gefen product that uses HDBaseT technology.

1. Select an HDBaseT product from the **Select Product** drop-down list.

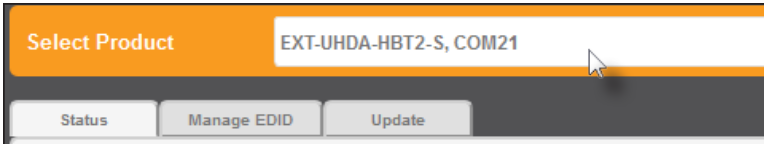

2. Under the **Status** tab will automatically be selected. If a Sender unit is selected, both the **Link Quality** and **Max Error Rate** graphs will be displayed. If a Receiver unit is selected, only the **Link Quality** graph will be displayed.

Sender unit

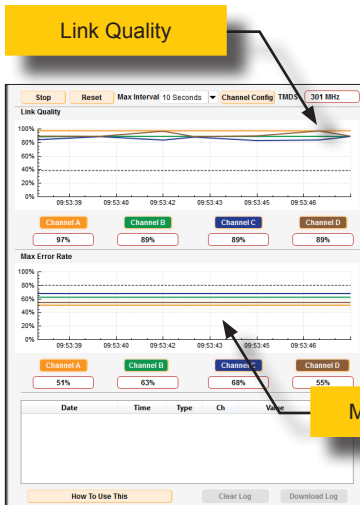

Receiver unit

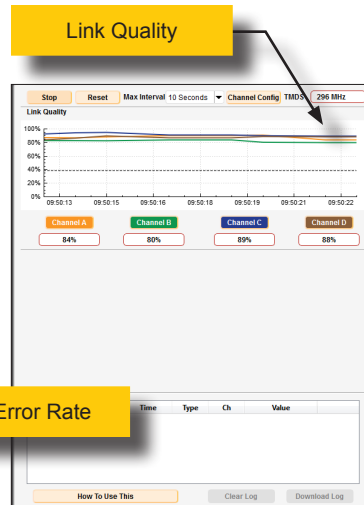

3. Click the **Channel Config** button, above the **Link Quality** graph.

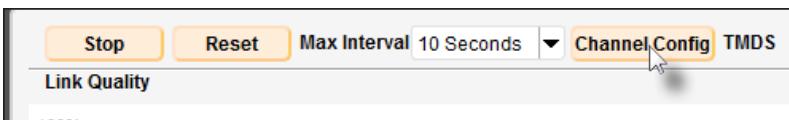

- The **Select a Channel Configuration** dialog box will be displayed.
- Click the radio button for the cable termination type. In the example, below, **T-568B** is selected.

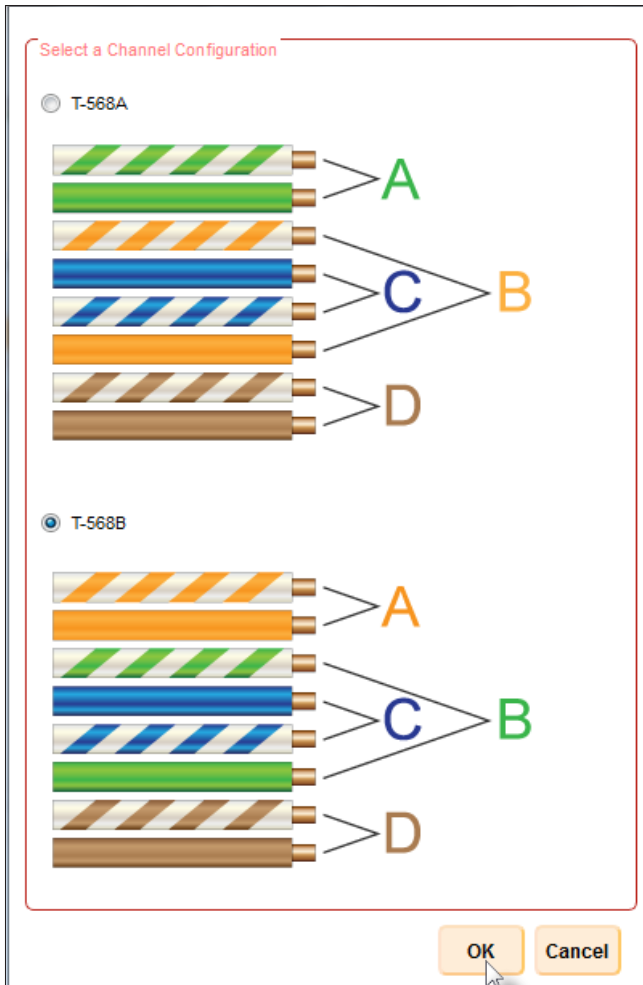

- Click the **OK** button to save the selection.

- Click the **Max Interval** drop-down list to select the desired time interval. This interval represent the maximum length of time before the graphs are updated.

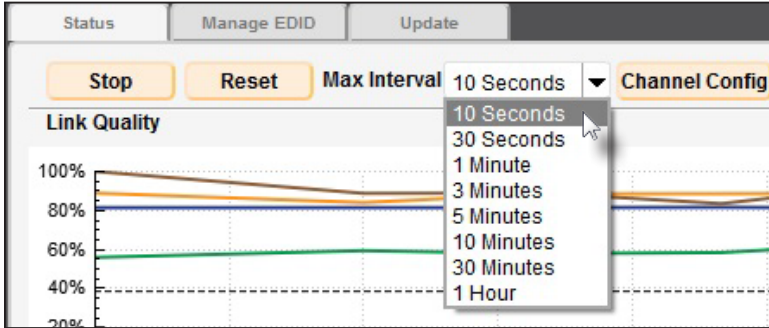

- To clear the channel data from both graphs, click the **Reset** button. Click the **Stop** button to halt the link monitoring process.

When the **Stop** button is clicked, the monitoring process will stop and the button will read **Start**. In addition, Syner-G will ask if the log file should be saved. To continue the monitoring process, click the **Start** button.

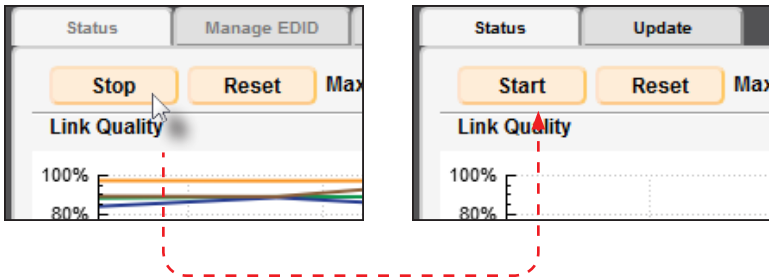

- Errors are automatically recorded and placed in the list box at the bottom of the Syner-G application, as shown.

	Date	Time	Type	Ch	
1	Tue Jun 21 2016	10:28:05	Max Err	B	99

In the example, below, the **Max Error Rate** for **Channel B** is 100%. Note the horizontal dashed-line at the 80% mark. This line represents the error rate threshold for each channel.

Since **Channel B** has exceeded the threshold, the channel's current value is highlighted in red, as shown below.

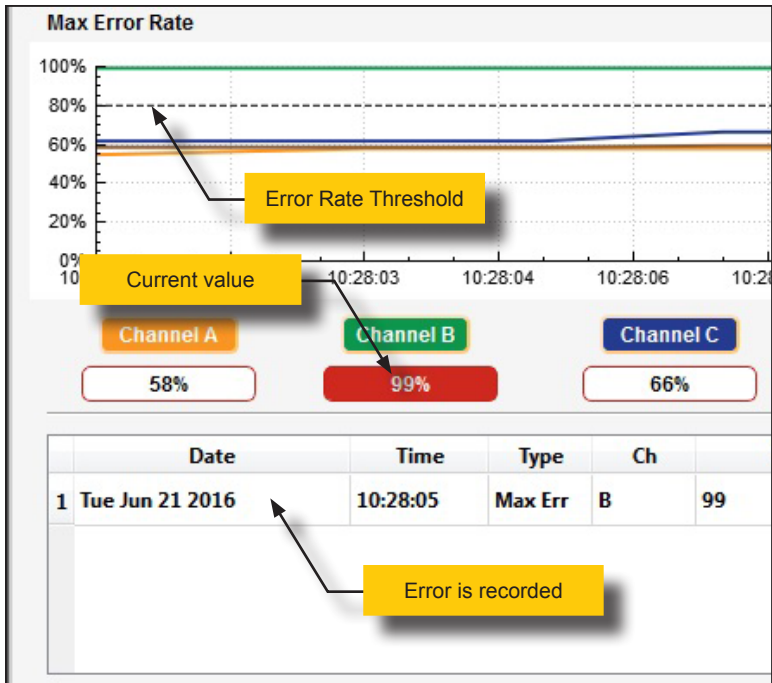

The following table provides a summary of the error type and the values that will trigger an error report. Note that a threshold value will also trigger a report.

Report Type	Range when value is recorded
Link Quality	40% or below
Max Error Rate	80% or above

- Press the **Clear Log** button, at any time, to clear all log entries.



Once the **Clear Log** button is pressed, the following dialog will be displayed, confirming the operation.

Click the **No** button to clear all reports in the list box. Note that once cleared, reports can **not** be recovered.

Click the **Yes** button to save the all current data to a `.csv` file. See the next step for more information on saving the current data to a file.

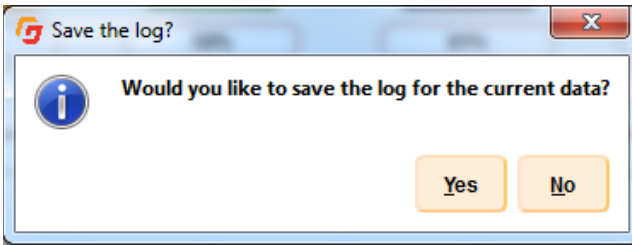

- Click the **Download Log** button to save all recorded error reports to a `.csv` file. The `.csv` file is a comma-delimited file which allows data to be save in a structured, table-type format, which can be opened using a spreadsheet application.

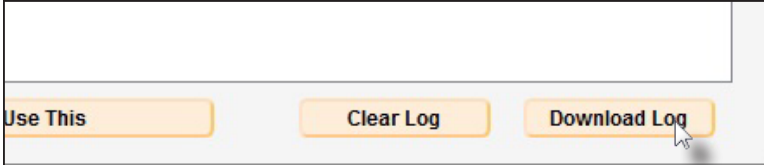

The **Save CSV** dialog will be displayed.

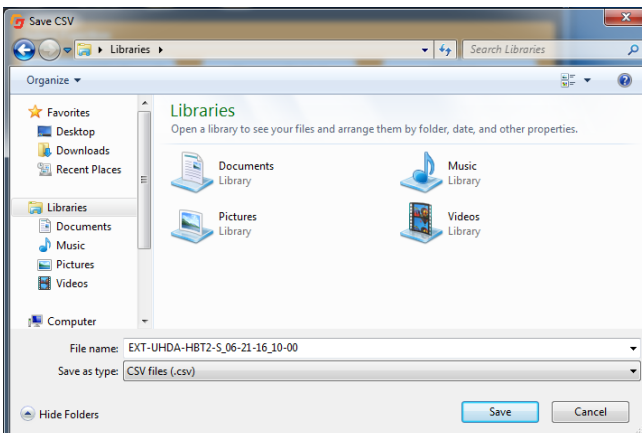

The filename will automatically be created and assigned to the **Filename** field. The name of the file can be changed, if desired.

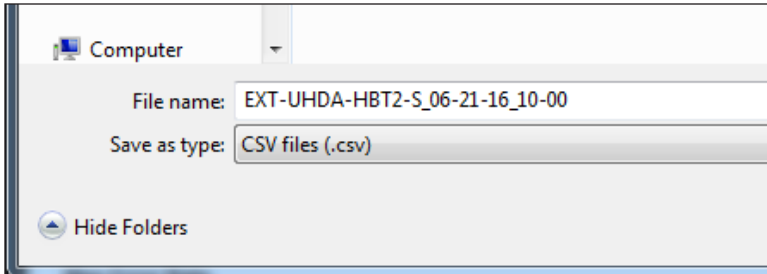

Click the **Save** button to save the file.

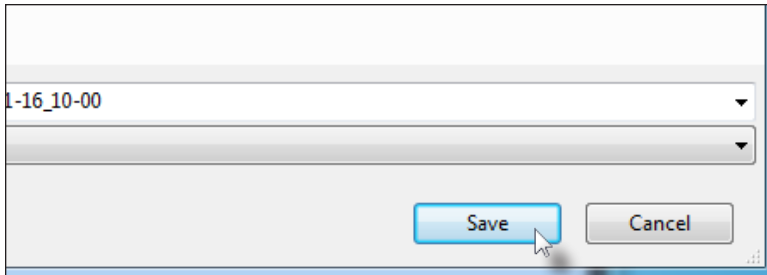

12. To display detailed information on the use of Link Monitoring, click the **How to Use This** button, at the bottom of the Syner-G application window.

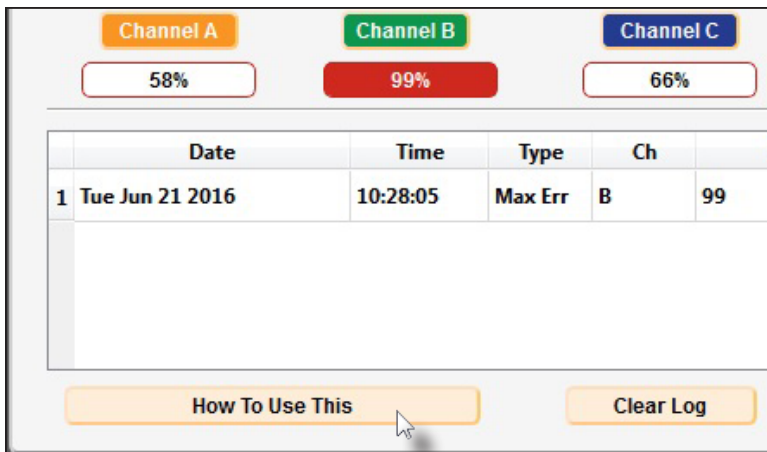

The **How to use this page** dialog will be displayed. It is recommended that this dialog be read in its entirety as it provides technical details on link monitoring.

To dismiss the dialog, click the **OK** button at the bottom of the dialog.

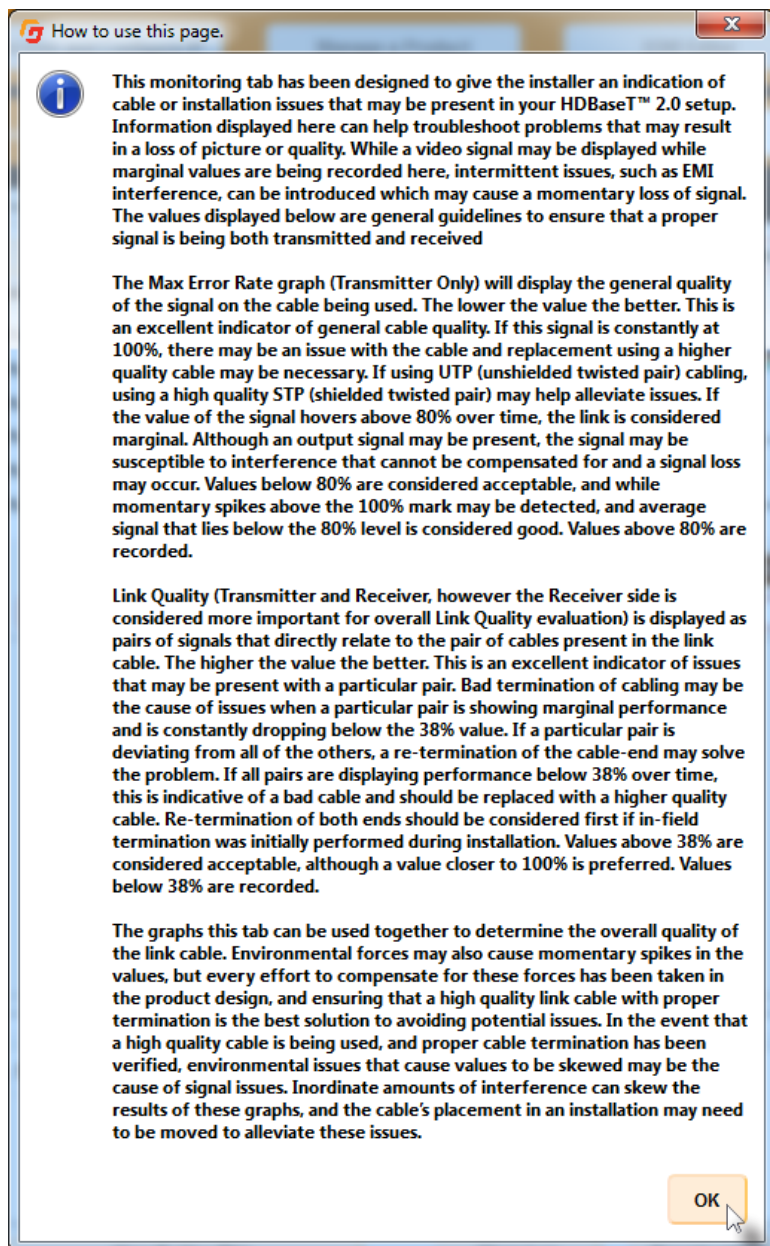

This page left intentionally blank.

4K ULTRA  **HD**

HDBaseT™ Extender

w/ Ethernet, RS-232, 2-way IR, 2-way Audio, and Bidirectional POH

4 Appendix

The Syner-G™ Software Suite provides an easy way to perform firmware updates. Before launching Syner-G™, make sure that a USB cable is connected between the product and the computer that is running the Syner-G™ software. Refer to the Syner-G™ Software Suite User Manual for more information on using other features with this product.

1. Launch the Syner-G™ Software Suite from the Start Menu or using the shortcut from the Windows Desktop.



2. Click the **Manage a Product** button.

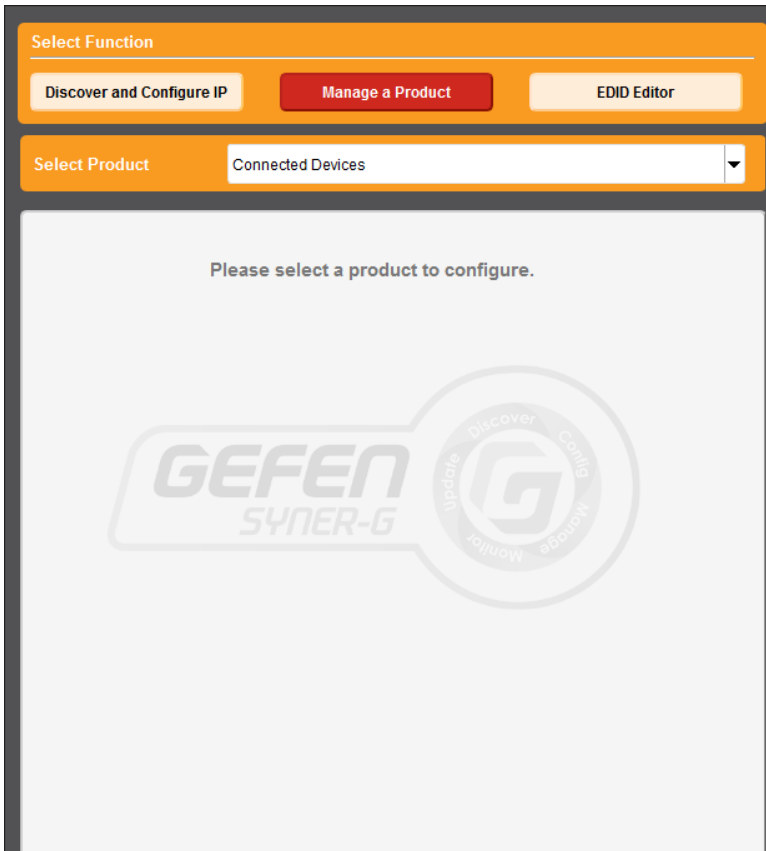

3. Select the product from the **Select your product** drop-down list.

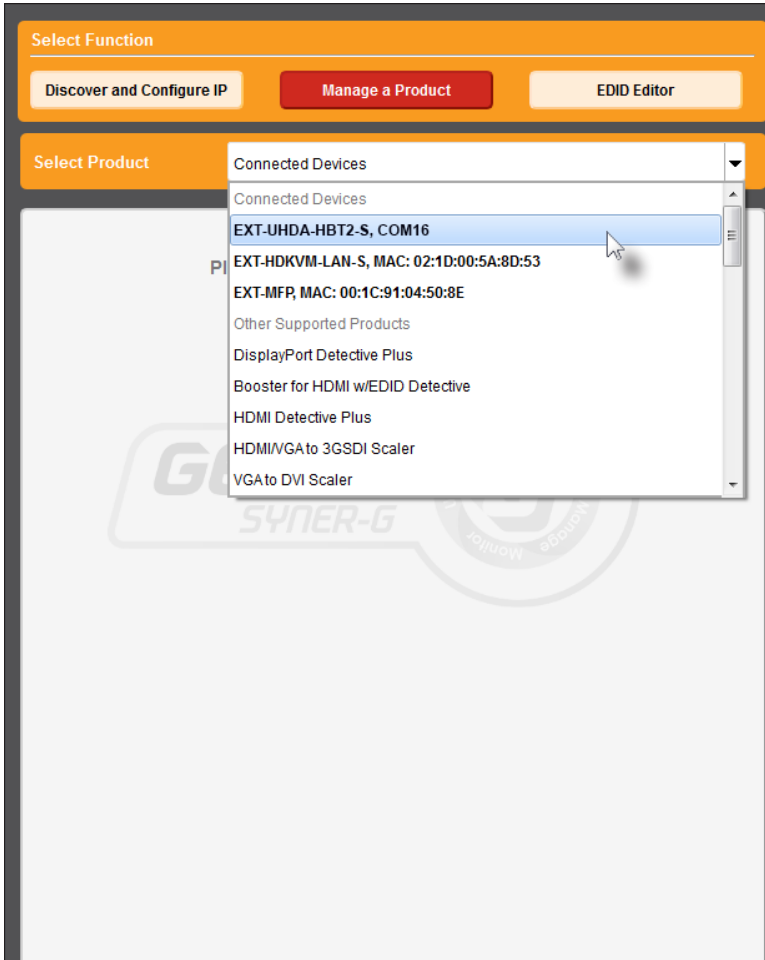

If the product is not detected by Syner-G™, then the product will not be listed in bold type, within the **Select your product** drop-down list. Verify the following:

- ▶ The product is powered and connected to the computer that is running the Syner-G™ Software Suite, using a USB-to-Mini USB cable.
- ▶ Make sure that the USB driver is installed and functioning correctly under Control Panel. See [Verifying the USB Driver \(page 24\)](#) for more information.

4. Click the **Update** tab.

The screenshot displays a web-based interface for managing a product. At the top, there are three main function buttons: "Discover and Configure IP", "Manage a Product" (highlighted in red), and "EDID Editor". Below this, a "Select Product" dropdown menu is set to "EXT-UHDA-HBT2-S, COM16".

The interface has three tabs: "Status", "Manage EDID", and "Update" (which is selected and highlighted with a mouse cursor). The "Update" tab contains the following elements:

- Product:** EXT-UHDA-HBT2-S
- Update Method:** USB Serial
- Current Firmware:** 1046024
- Latest Firmware:** 1046024
- Check at Startup:** Enabled (indicated by a red button)
- Last Checked:** Fri Dec 4 17:50:31 2015
- Check for Latest Update:** Button

A text area below these fields contains the text: "First production firmware."

The "Product Options" section shows "None".

The "Download and Install" section includes:

- Download Latest Version to Gefen Syner-G:** A progress bar at 0% with a "Start" button.
- Download to Computer:** A "Save" button.

The "Install from File" section includes:

- Select File to Upload:** A text input field with a "Browse" button.
- Install:** A button.

- Click the **Start** button to begin downloading the firmware.

The screenshot shows the Syner-G™ Software Suite interface for managing a product. At the top, there are three buttons: "Discover and Configure IP", "Manage a Product", and "EDID Editor". Below this is a "Select Product" dropdown menu currently showing "EXT-UHDA-HBT2-S, COM16". A navigation bar contains "Status", "Manage EDID", and "Update" tabs. The main content area is divided into several sections:

- Product Information:** "Product: EXT-UHDA-HBT2-S", "Update Method: USB Serial", "Current Firmware: 1046024", "Latest Firmware: 1046024", and "Last Checked: Fri Dec 4 17:50:31 2015".
- Buttons:** "Check at Startup Enabled" (red), "Check for Latest Update" (orange), and "Start" (red) in the "Download and Install" section.
- Progress:** A progress bar for "Download Latest Version to Gefen Syner-G" is currently at 0%.
- Other Options:** "Download to Computer" (orange), "Save" (orange), "Install from File" (grey), "Select File to Upload" (text input), "Browse" (orange), and "Install" (grey).

The Syner-G™ Software Suite will automatically download the firmware file for the selected product. This process should take a few seconds.

Once the download process has completed, the progress bar will indicate 100%, as shown on the next page.

A message will also appear at the bottom of the window, indicating that the firmware file was successfully downloaded.

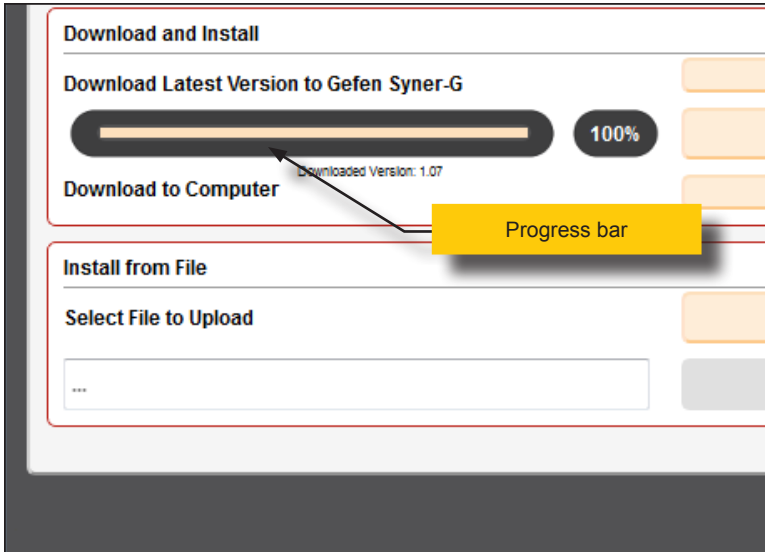

- Click the **Install** button to begin installing the software.

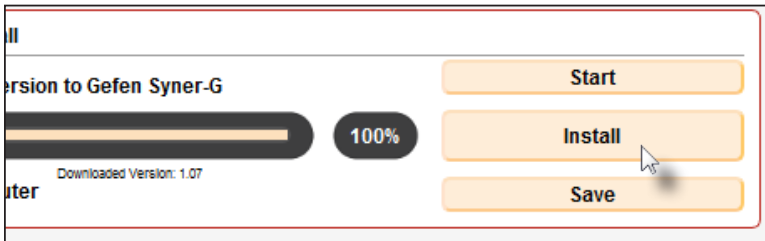

- The installation process will begin and the progress bar will indicate the current status.

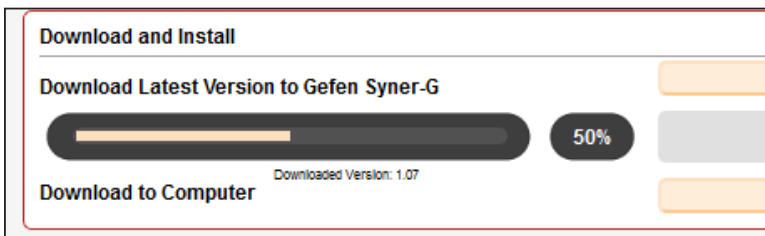

- After the firmware update process has completed, the following message will be displayed.

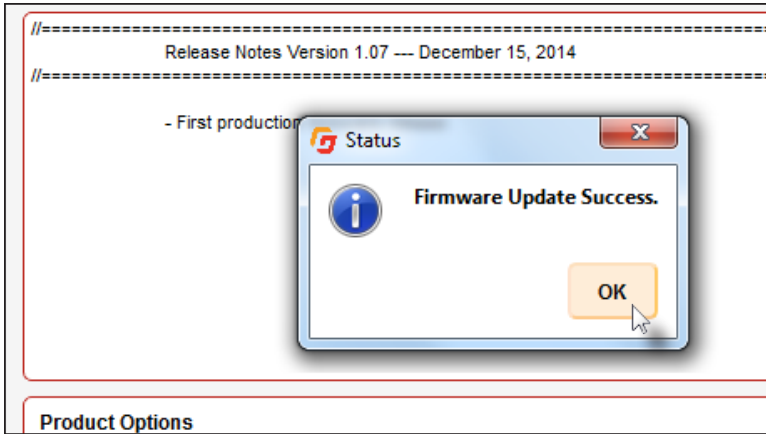

- Click the **OK** button to dismiss the message box.
- The procedure is now complete.

Sender unit default settings

DIP swtich	Funciton	Default setting (OFF position)
1	EDID mode	Internal EDID
2	HPD (Hot Plug Detect)	High
3	EDID lock	Disabled
4	HDCP	Pass-through
5	IR carrier	Pass-through to Receiver unit
6	IR carrier	Pass-through to Sender unit
7	IR polarity	Uses Gefen part no. EXT-RMT-EXTIRN
8	HDBT mode	Enabled
9	IR carrier frequency	38 kHz
10	IR carrier frequency	38 kHz
11	N/A	---
12	N/A	---

Receiver unit default settings

DIP swtich	Funciton	Default setting (OFF position)
1	IR carrier	Pass-through to Receiver unit
2	IR carrier	Pass-through to Sender unit
3	IR polarity	Uses Gefen part no. EXT-RMT-EXTIRN
4	HDBT mode	Enabled
5	IR carrier frequency	38 kHz
6	IR carrier frequency	38 kHz
7	N/A	---
8	N/A	---

Front of RJ-45 Connector

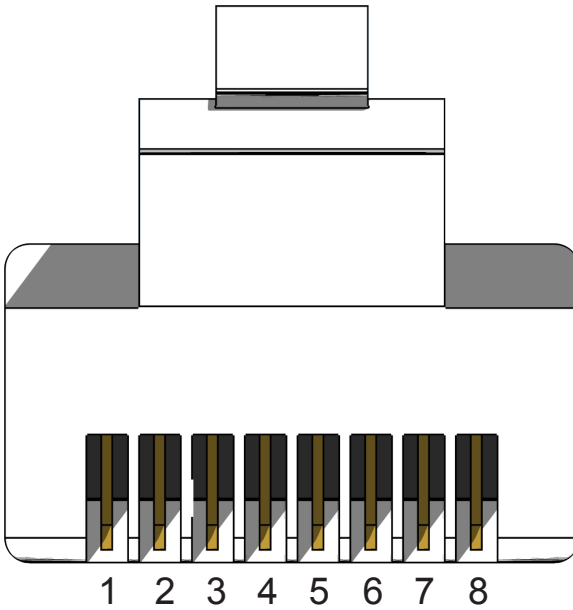

Gefen recommends the TIA/EIA-568-B wiring option. Use the table below when field-terminating cable for use with Gefen products.

Pin	Color	Description
1	Orange / White	TD+ (Transmit Data, positive differential signal)
2	Orange	TD- (Transmit Data, negative differential signal)
3	Green / White	RD+ (Receive Data, positive differential signal)
4	Blue	Unused
5	Blue / White	Unused
6	Green	RD- (Receive Data, negative differential signal)
7	Brown / White	Unused
8	Brown / White	Unused

 **Information**
Shielded CAT-5e (or better) cabling is recommended.

Supported Formats

Resolutions (max.)	<ul style="list-style-type: none"> • 3840 x 2160p 60 Hz (4:2:0) • 4096 x 2160p 30 Hz (4:4:4) • 3840 x 2160p 30 Hz (4:4:4)
--------------------	--

Connectors, Controls, and Indicators

HDMI In (Sender)	• 1 x Type A 19-pin female, locking
HDMI Out (Receiver)	• 1 x Type A 19-pin female, locking
RS-232 (Sender)	• 1 x DB-9, female
RS-232 (Receiver)	• 1 x DB-9, male
Link (Sender / Receiver)	• 1 x RJ-45, shielded
Ethernet (Sender / Receiver)	• 1 x RJ-45, shielded
IR In / Ext (Sender / Receiver)	• 1 x 3.5mm mini-stereo
IR Out (Sender / Receiver)	• 1 x 3.5mm mini-mono
Optical Audio Out (Sender)	• 1 x TOSLINK®
Optical Audio In (Receiver)	• 1 x TOSLINK®
Analog Audio In (Sender)	• 2 x RCA, female
Analog Audio Out (Receiver)	• 2 x RCA, female
POH 48V DC (Sender)	• 1 x 48 V DC power connector
Non-POH 48V DC (Receiver)	• 1 x 48 V DC power connector
USB (Sender / Receiver)	• 1 x Mini-B type (for Gefen Syner-G)
DIP switches (Sender)	• 12 x piano type, 4 per bank
DIP switches (Receiver)	• 8 x piano type, 4 per bank
Link Indicator (Sender / Receiver)	• 1 x LED, blue
Video Indicator (Sender / Receiver)	• 1 x LED, amber
Power Indicator (Sender / Receiver)	• 1 x LED, green

Operational

Maximum pixel clock	• 300 MHz
Power input	• 48 V DC
Power consumption	• 14 W (Sender / Receiver combined)
Analog audio	
Input Level (max.)	• 2 Vrms
THD	• < 0.01% @ 1 kHz, 2 Vrms
Frequency Response	• 20 Hz - 20 kHz +/- 0.5 dB
SNR	• >= 90 dB (20 Hz - 20 kHz +/- 0.5 dB)

Operational	
Digital audio (S/PDIF)	
Input Level (max.)	• 2 Vrms
THD	• < 0.03% (at 1 kHz, 2 Vrms)
Frequency Response	• 20 Hz - 20 kHz +/- 0.5 dB
SNR	• > 90 dB (20 Hz - 20 kHz)
Sampling Rate (max.)	• 96 kHz
Operating temperature	
Operating temperature	• +32 to +122 °F (0 to +50 °C)
Operating humidity	
Operating humidity	• 5% to 90% RH, non-condensing
Storage temperature	
Storage temperature	• -4 to +185 °F (-20 to +85 °C)
Storage humidity	
Storage humidity	• 0% to 95% RH, non-condensing
MTBF	
MTBF	• 50000 hours

Physical	
Dimensions (W x D x H) (Sender / Receiver)	
Dimensions (W x D x H) (Sender / Receiver)	• 8.5" x 1" x 4" (214mm x 25mm x 100mm)
Unit weight	
Unit weight	• 0.75 lbs (0.35 kg)

A

Application Diagram 7

C

Connection Instructions 6

D

Default Settings

receiver unit 52

sender unit 52

DIP Switch Configuration

receiver unit 12

sender unit 10

E

EDID

copying 31

downloading 26

settings 10

uploading 29

viewing 33

F

Features *vi*

Firmware

updating 46

H

HDCP Control 11

HPD Control 10

I

IR Carrier

filter 11, 13

frequency 12, 13

IR Control

controlling source and display 18

controlling the display 17

controlling the source 16

IR Polarity 11, 13

L

LED Status 15

Link Quality 37

channel configuration 37

clearing logs 40

error logging 39

help 42

link quality graph 37

max error rate graph 37

max interval 39

saving logs 41

start monitoring 39

stop monitoring 39

thresholds 40

Long-Reach Mode 11, 13

N

Network Cable Diagram 53

O

Operating Notes *v*

P

Packing List *vii*

R

RS-232 Interface 19

S

Safety Instructions *ii*

Specifications 54

Syner-G

copying an EDID 31

downloading an EDID 26

link quality. See Link Quality

updating the firmware 46

uploading an EDID 29

using 24

viewing an EDID 33

T

Table of Contents *viii*

Technical Support *iv*

U

Updating the Firmware *46*

USB Driver
 verifying 24

W

Warranty Information *iii*



1800 S McDowell Blvd. Petaluma CA 94954
(707) 283-5900 (800) 472-5555