

**E-DAT Industry RJ45 field jack insert / RJ45 coupler insert/ USB A coupler insert
OpDAT Industry SC-RJ/ 2SC adaptor insert MM / SC-RJ/2SC adaptor insert SM
OpDAT Industry LC-D adaptor insert MM / LC-D adaptor insert SM**

Montagehinweis / Mounting informations / Références de montage / Indicaciones de montaje / Informazioni per il montaggio

1

2

Wandstärke wall thickness 1-3 mm

V1M / V1

U-Scheibe M3/U-washer M3
DIN EN ISO 7092
Polyamid (PA) 6.6

Wandstärke / wall thickness > 1 mm

3

V4

Wandstärke wall thickness > 1 mm

4

V14M Standard

Wandstärke wall thickness > 1 mm

V14M Central

Wandstärke / wall thickness 1-5 mm

5

V5M

Wandstärke / wall thickness > 1 mm

U-Scheibe M3/U-washer M3
DIN EN ISO 7092
Polyamid (PA) 6.6

6

7

8

9

10

11

Druckfehler und technische Änderungen vorbehalten / Printing errors and technical changes reserved

D 875030A0310h 899155 2.03.2015© by METZ CONNECT

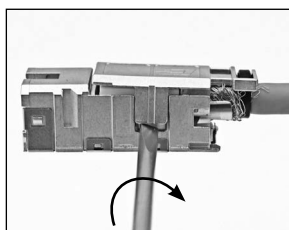
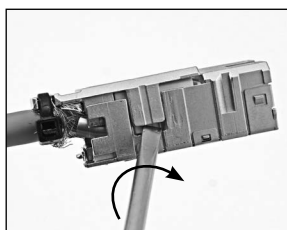
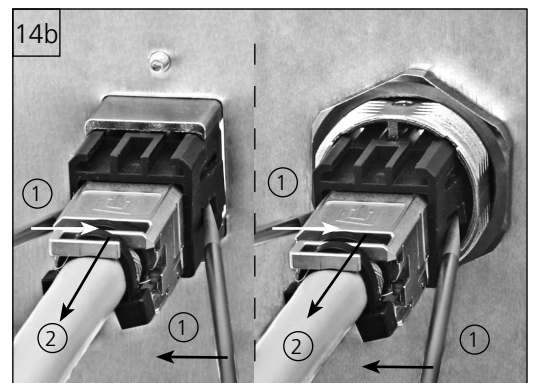
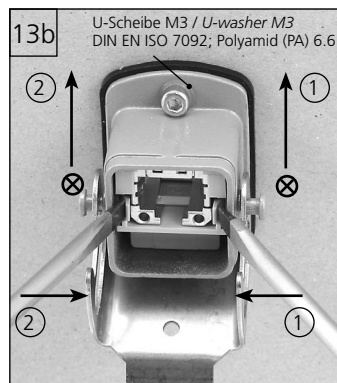
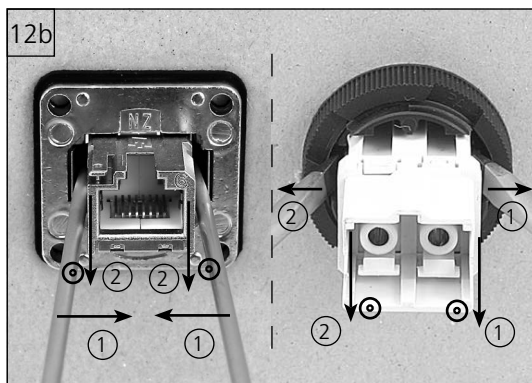
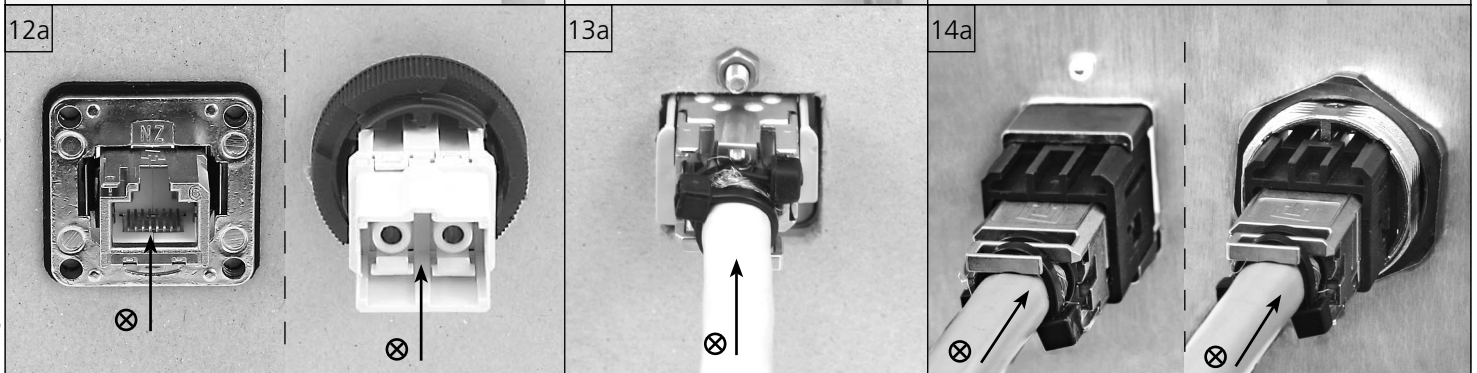
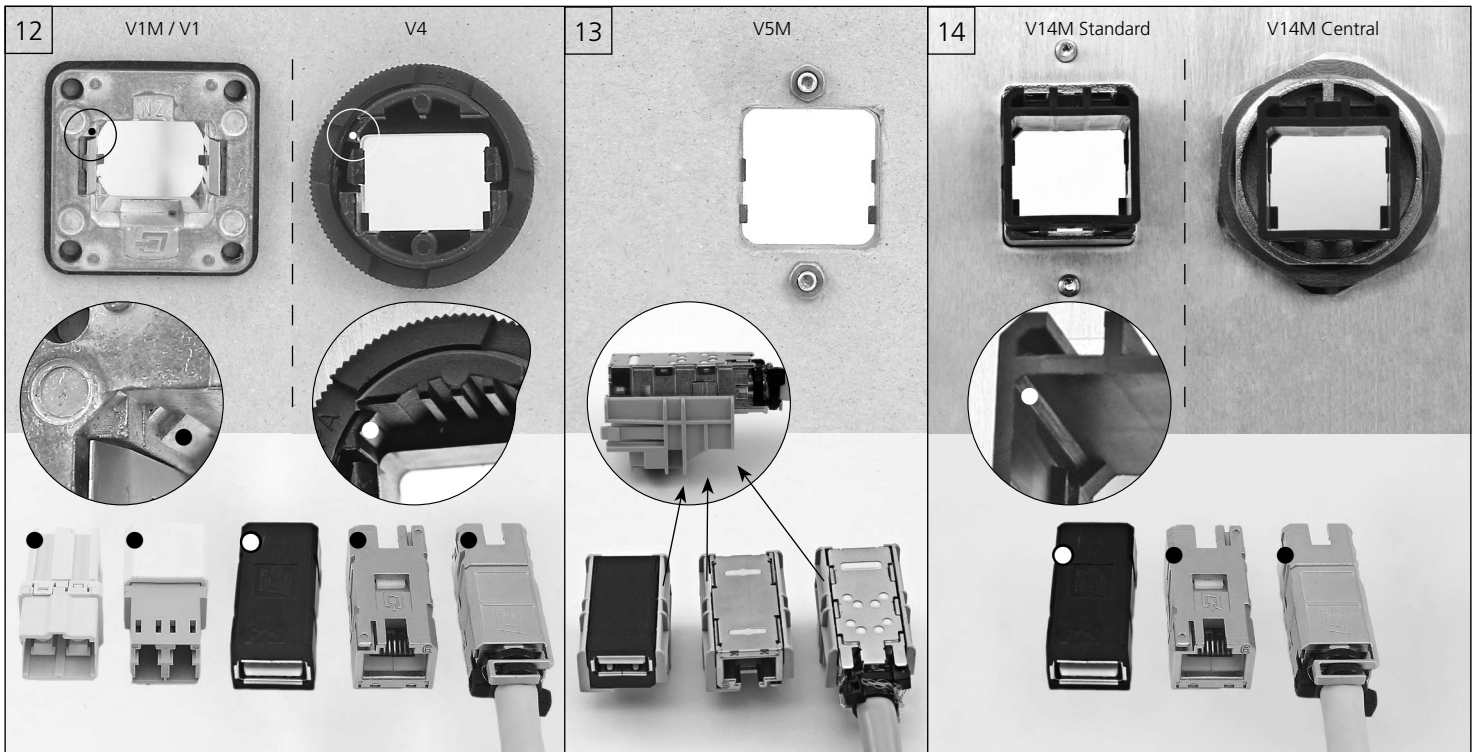

		Anschluss / Connection				Anwendung / Application				
RJ45 PIN Nr./No.	Farbcode Colour code T568		DIN 47100	Industrial	10BT/ 100BT	1 Gigabit 10 Gigabit Ethernet	Token Ring ISDN/So	Upo/ TEL		
	A	B								
1	WH-GN	WH-OG	WH	YE	•	•				
2	GN	OG	BN	OG	•	•				
3	WH-OG	WH-GN	GN	WH	•	•	•			
4	BU	BU	YE	-			•	•	•	
5	WH-BU	WH-BU	GY				•	•	•	
6	OG	GN	PK	BU	•		•	•		
7	WH-BN	WH-BN	BU	-			•			
8	BN	BN	RD	-			•			

Weitere Demontageschritte nach Montageanleitung / further demounting steps according to the mounting instructions