

16<sub>x</sub>16  
sources displays

# Modular Matrix for HDMI with HDCP

GEF-HDFST-MOD-16416-HD  
GEF-HDFST-MOD-16416-HDEL R

User Manual  
Release A8



**Gefen PRO**®

# Important Safety Instructions

## GENERAL SAFETY INFORMATION

1. Read these instructions.
2. Keep these instructions.
3. Heed all warnings.
4. Follow all instructions.
5. Do not use this product near water.
6. Clean only with a dry cloth.
7. Do not block any ventilation openings. Install in accordance with the manufacturer's instructions.
8. Do not install or place this product near any heat sources such as radiators, heat registers, stoves, or other apparatus (including amplifiers) that produce heat.
9. Do not defeat the safety purpose of the polarized or grounding-type plug. A polarized plug has two blades with one wider than the other. A grounding type plug has two blades and a third grounding prong. The wide blade or the third prong are provided for your safety. If the provided plug does not fit into your outlet, consult an electrician for replacement of the obsolete outlet.
10. Protect the power cord from being walked on or pinched particularly at plugs, convenience receptacles, and the point where they exit from the apparatus.
11. Only use attachments/accessories specified by the manufacturer.
12. To reduce the risk of electric shock and/or damage to this product, never handle or touch this unit or power cord if your hands are wet or damp. Do not expose this product to rain or moisture.
13. Unplug this apparatus during lightning storms or when unused for long periods of time.
14. Refer all servicing to qualified service personnel. Servicing is required when the apparatus has been damaged in any way, such as power-supply cord or plug is damaged, liquid has been spilled or objects have fallen into the apparatus, the apparatus has been exposed to rain or moisture, does not operate normally, or has been dropped.
15. Batteries that may be included with this product and/or accessories should never be exposed to open flame or excessive heat. Always dispose of used batteries according to the instructions.

## RACK MOUNT SAFETY INFORMATION

- a. Maximum recommended ambient temperature: 40 °C (104 °F).
- b. Increase the air flow as needed to maintain the recommended temperature inside the rack.
- c. Do not exceed maximum weight loads for the rack. Install heavier equipment in the lower part of the rack to maintain stability.

# Warranty Information

Gefen warrants the equipment it manufactures to be free from defects in material and workmanship.

If equipment fails because of such defects and Gefen is notified within two (2) years from the date of shipment, Gefen will, at its option, repair or replace the equipment, provided that the equipment has not been subjected to mechanical, electrical, or other abuse or modifications. Equipment that fails under conditions other than those covered will be repaired at the current price of parts and labor in effect at the time of repair. Such repairs are warranted for ninety (90) days from the day of reshipment to the Buyer.

This warranty is in lieu of all other warranties expressed or implied, including without limitation, any implied warranty or merchantability or fitness for any particular purpose, all of which are expressly disclaimed.

1. Proof of sale may be required in order to claim warranty.
2. Customers outside the US are responsible for shipping charges to and from Gefen.
3. Copper cables are limited to a 30 day warranty and cables must be in their original condition.

The information in this manual has been carefully checked and is believed to be accurate. However, Gefen assumes no responsibility for any inaccuracies that may be contained in this manual. In no event will Gefen be liable for direct, indirect, special, incidental, or consequential damages resulting from any defect or omission in this manual, even if advised of the possibility of such damages. The technical information contained herein regarding the features and specifications is subject to change without notice.

For the latest warranty coverage information, refer to the Warranty and Return Policy under the Support section of the Gefen Web site at [www.gefen.com](http://www.gefen.com).

## PRODUCT REGISTRATION

**Please register your product online by visiting the Register Product page under the Support section of the Gefen Web site.**

# Contacting Gefen Technical Support

Gefen, LLC  
c/o Customer Service  
20600 Nordhoff St.  
Chatsworth, CA 91311

Telephone: (818) 772-9100  
(800) 545-6900

Fax: (818) 772-9120

Email: [support@gefenpro.com](mailto:support@gefenpro.com)

Visit us on the Web: [www.gefenpro.com](http://www.gefenpro.com)

Technical Support Hours: 8:00 AM to 5:00 PM Monday - Friday, Pacific Time

For 24 / 7 support, see the back of the product for the support number

**16x16 Modular Matrix for HDMI w/ HDCP**  
is a trademark of Gefen, LLC.

### **Important Notice**

Gefen, LLC reserves the right to make changes in the hardware, packaging, and any accompanying documentation without prior written notice.

© 2015 Gefen, LLC. All Rights Reserved.  
All trademarks are the property of their respective owners.

## Operating Notes

- There is no internal scaling in the 16x16 Modular Matrix for HDMI w/ HDCP. All of the attached monitors must be able to display the output resolutions of the source devices. For maximum compatibility it is recommended that only one compatible/common resolution be used by all of the source devices.
- Routing features can be accessed using RS-232 or IP control. See [RS-232 and IP Configuration](#) for more information.
- The 16x16 Modular Matrix for HDMI w/HDCP is available in several pre-configured versions to meet the requirements of your particular application. This User Manual covers both configurations. See [Pre-Configured Options](#) for additional information.
- The **IR In** ports (including **IR All In**) are designed to accept an electrical IR connection from third-party automation devices. These ports will not work with Gefen IR extenders.
- The **IR Ext** port, on the Receiver units, are designed to work with the Gefen EXT-RMT-EXTIRN extender. This port will not work with the electrical IR connection from an automation control device.

# Licensing

This product uses software that is subject to open source licenses, including one or more of the General Public License Version 2 and Version 2.1, Lesser General Public License Version 2.1 and Version 3, BSD, and BSD-style licenses. Distribution and use of this product is subject to the license terms and limitations of liability provided in those licenses. Specific license terms and Copyright Notifications are provided in the source code.

For three years from date of activation of this product, any party may request, and we will supply, for software covered by an applicable license (e.g. GPL or LGPL), a complete machine-readable copy of the corresponding open source code on a medium customarily used for software interchange. The following software and libraries are included with this product and subject to their respective open source licenses:

- lwIP
- jQuery

lwIP is licenced under the BSD licence:

Copyright (c) 2001-2004 Swedish Institute of Computer Science.  
All rights reserved.

Redistribution and use in source and binary forms, with or without modification, are permitted provided that the following conditions are met:

1. Redistributions of source code must retain the above copyright notice, this list of conditions and the following disclaimer.
2. Redistributions in binary form must reproduce the above copyright notice, this list of conditions and the following disclaimer in the documentation and/or other materials provided with the distribution.
3. The name of the author may not be used to endorse or promote products derived from this software without specific prior written permission.

THIS SOFTWARE IS PROVIDED BY THE AUTHOR "AS IS" AND ANY EXPRESS OR IMPLIED WARRANTIES, INCLUDING, BUT NOT LIMITED TO, THE IMPLIED WARRANTIES OF MERCHANTABILITY AND FITNESS FOR A PARTICULAR PURPOSE ARE DISCLAIMED. IN NO EVENT SHALL THE AUTHOR BE LIABLE FOR ANY DIRECT, INDIRECT, INCIDENTAL, SPECIAL, EXEMPLARY, OR CONSEQUENTIAL DAMAGES (INCLUDING, BUT NOT LIMITED TO, PROCUREMENT OF SUBSTITUTE GOODS OR SERVICES; LOSS OF USE, DATA, OR PROFITS; OR BUSINESS INTERRUPTION) HOWEVER CAUSED AND ON ANY THEORY OF LIABILITY, WHETHER IN CONTRACT, STRICT LIABILITY, OR TORT (INCLUDING NEGLIGENCE OR OTHERWISE) ARISING IN ANY WAY OUT OF THE USE OF THIS SOFTWARE, EVEN IF ADVISED OF THE POSSIBILITY OF SUCH DAMAGE.

# Features and Packing List

## Features

- Supports resolutions up to 1080p Full HD
- HDMI Features Supported
  - ▶ HDCP compliant
  - ▶ 12-bit Deep Color
  - ▶ LPCM 7.1, Dolby® TrueHD, and DTS-HD Master Audio™
  - ▶ Lip-Sync pass-through
- ELR and HDBaseT® technologies allow extension up to 330 feet (100 meters)
- POL feature provides power to each ELR receiver through the CAT-5e cable
- Gefen FST speeds up the HDCP authentication process
- Fast and Slow FST Modes
- Advanced EDID management for rapid integration of sources and displays
- Front-panel display for status feedback
- Front-panel push buttons for local switching
- IP controlled via built-in web server, Telnet, and UDP
- RS-232 Serial interface for remote control via an automation control system
- IR control of the matrix via front panel sensor and from each Receiver location
- Broadcast of IR commands from the matrix side to all viewing locations, and from each receiver location to the matrix all sources
- Routing states can be stored and recalled at the touch of a button
- Output masking command
- Optional IR remote control (RMT-MOD-IRN)
- Stand-by mode
- Field upgradable firmware via USB or IP
- Dual redundant hot-swappable power supplies
- Rack-mountable



## Packing List

See [Pre-Configured Options](#) for packing list details for each pre-configured option. If any of these items are not present in your box when you first open it, immediately contact your dealer or Gefen.

# Table of Contents

## 01 Getting Started

Pre-Configured Options.....	2
Panel Layout .....	3
Front Panel.....	3
Back Panel.....	4
IR Remote Control Unit.....	6
Front.....	6
Back .....	8
Installing the Battery.....	9
Setting the IR Channel.....	9
Installation .....	10
Sample Wiring Diagram .....	10
GEF-HDFST-MOD-16416-HD .....	11
GEF-HDFST-MOD-16416-HDELR .....	11

## 02 Operating the 16x16 Modular Matrix for HDMI w/ HDCP

Basic Operation.....	16
Standby Mode.....	16
Powering the Matrix .....	16
Accessing the Menu System.....	17
Menu System .....	19
IP Configuration Menu .....	19
Temperature Menu.....	21
LCM Contrast Menu.....	22
Routing Basics .....	23
Displaying the Current Routing Status .....	23
Routing a Source to an Output.....	24
Routing a Source to Multiple Outputs .....	28
Routing a Source to All Outputs.....	30
Saving a Routing Preset .....	32
Recalling a Saved Routing Preset .....	34
Locking the Matrix.....	36
IR Control .....	37
Controlling the Display from the Source Location.....	37
Controlling the Source from the Viewing Location .....	38
Controlling Multiple Sources .....	39
Controlling the Matrix from the Viewing Location.....	40



## 03 Advanced Operation

RS-232 and IP Configuration .....	44
RS-232 Interface .....	44
RS-232 Settings .....	44
IP / UDP Configuration .....	45
Commands .....	46
IP Configuration .....	46
UDP Configuration .....	57
FST .....	61
Routing and Masking .....	64
System .....	74
Web Interface .....	94
Using the built-in Web Server .....	94
Main ► Routing .....	95
Main ► I/O Status .....	101
Main ► Display Info .....	103
I/O Setup ► Preset Names .....	104
I/O Setup ► I/O Names .....	105
I/O Setup ► HPD Control .....	106
I/O Setup ► FST .....	107
I/O Setup ► HDCP .....	108
Manage EDID ► Assign .....	109
Manage EDID ► Bank Names .....	112
Manage EDID ► Upload/Download .....	113
Configuration ► Change IP Settings .....	114

## 04 Appendix

Card Removal and Installation .....	122
Power Supply Failure and Replacement .....	125
Power Supply Failure .....	125
Power Supply Replacement .....	126
Firmware Upgrade Procedure .....	128
Upgrading using the Web interface .....	128
Upgrading using USB .....	129
Specifications .....	130



16<sub>x</sub>16  
sources displays

# Modular Matrix for HDMI with HDCP

## 01 Getting Started

Pre-Configured Options.....	2
Panel Layout .....	3
Front Panel.....	3
Back Panel .....	4
IR Remote Control Unit.....	6
Front.....	6
Back .....	8
Installing the Battery.....	9
Setting the IR Channel.....	9
Installation .....	10
Sample Wiring Diagram .....	10
GEF-HDFST-MOD-16416-HD .....	11
GEF-HDFST-MOD-16416-HDELR .....	11

## Pre-Configured Options

The following list outlines the available pre-configured options. Because this User Manual covers information on all available configurations, it is important to identify the type of 16x16 Modular Matrix for HDMI w/ HDCP that was purchased.

### ► **16 HDMI Inputs / 16 HDMI Outputs (GEF-HDFST-MOD-16416-HD)**

Two input cards. Each card uses eight HDMI inputs, providing a total of 16 HDMI inputs.

Two output cards. Each card uses eight HDMI outputs, providing a total of 16 HDMI outputs.

Packing List:

- (1) 16x16 Modular Matrix for HDMI w/ HDCP Frame
- (2) Modular Matrix 8 HDMI Input Cards
- (2) Modular Matrix 8 HDMI Output Cards
- (1) DB-9 cable
- (2) AC power cords
- (1) Quick-Start Guide

### ► **16 HDMI Input / 16 CAT-5 ELR-POL Outputs (GEF-HDFST-MOD-16416-HDELRL)**

Two input cards. Each card uses eight HDMI inputs, providing a total of 16 HDMI inputs.

Two output cards. Each card uses eight ELR-POL outputs. Each of these ELR-POL outputs are connected to a Receiver unit, using a CAT-5e cable, allowing you to extend the HDMI signal up to 330 feet (100 meters). 16 ELR-POL Receiver units are included with this package option.

Packing List:

- (1) 16x16 Modular Matrix for HDMI w/ HDCP Frame
- (2) Modular Matrix 8 HDMI Input Cards
- (2) Modular Matrix 8 HDMI Sender over CAT-5 Cards
- (16) HDMI ELR Receivers with POL
- (1) DB-9 Cable
- (2) AC Power Cords
- (1) Quick-Start Guide

# Panel Layout

## Front Panel

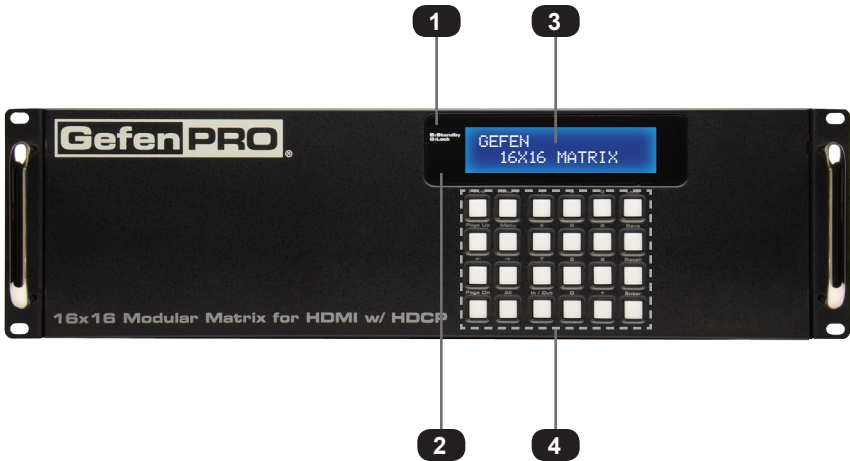

ID	Name	Description
1	Standby / Lock (LED)	When the matrix is in standby mode, this LED indicator will glow bright blue. When the matrix is locked, the LED indicator will glow bright green. See <a href="#">Locking the Matrix</a> for more information.
2	IR sensor	This IR sensor receives signals from an IR remote.
3	Front panel display	Provides feedback and matrix status during various operations.
4	Front panel buttons	Used to control various features on the Matrix. See the section <a href="#">Basic Operation</a> for more information.

## Back Panel

(GEF-HDFST-MOD-16416-HDEL R shown)

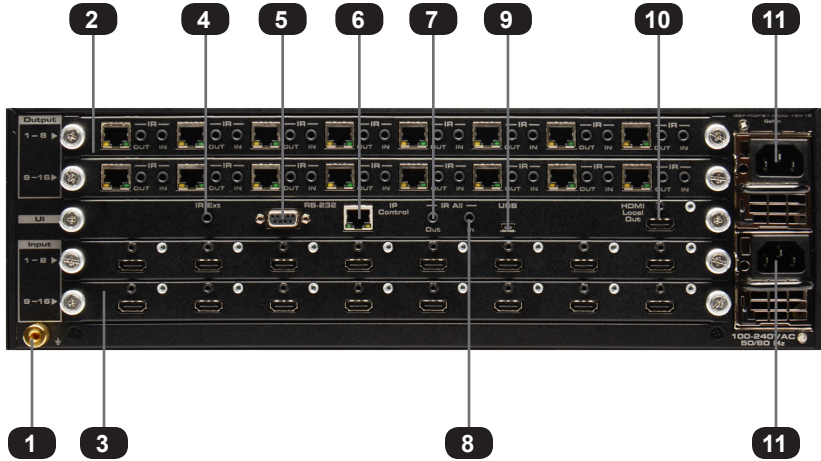

ID	Name	Description
1	Grounding terminal	Connect a grounding wire from the grounding terminal to an approved ground path.
2	Output (1 - 16)	These two expansion bays accept Output cards, only (HDMI or ELR).
3	Input (1 - 16)	These two expansion bays accept Input cards, only (HDMI).
4	IR Ext	Connect an IR Extender (Gefen part no. EXT-RMT-EXTIRN) to this port.
5	RS-232	Connect the included RS-232 cable from this port to an RS-232 device. See <a href="#">RS-232 and IP Configuration</a> for more information.
6	IP Control	Connect an Ethernet cable between this jack and a LAN to use IP control. See <a href="#">RS-232 and IP Configuration</a> for more information.

7	IR All (Out)	Connect an IR blaster to this port to send IR commands to multiple devices. This port is only active if the unit is configured with the ELR-POL Output option.
8	IR All (In)	This port is designed to be used with an IP-based automation control device. Connect the IR cable from an IR Emitter port on the automation control device to this IR port. This port is only active if the unit is configured with the ELR-POL Output option.
9	USB	This mini USB port is used for upgrading the firmware. See <a href="#">Upgrading using USB</a> for more information.
10	HDMI Local Out	Connect a local HDTV display to this HDMI port. This port is useful for monitoring the currently routed input signal.
11	IEC connector	Connect the included AC power cords from these power receptacles to available electrical outlets.

## IR Remote Control Unit

The IR remote control unit (Gefen part no. RMT-MOD-IRN) is not included 16x16 Modular Matrix for HDMI with HDCP but can be purchased separately.

### Front

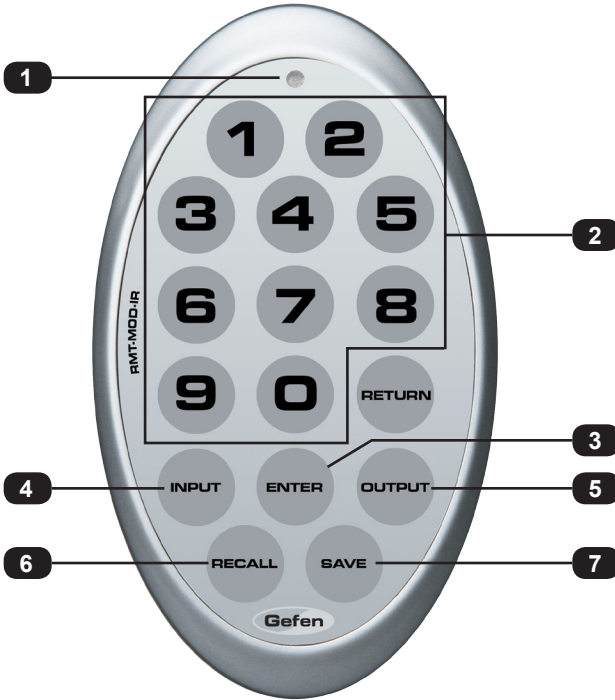

ID	Name	Description
1	Activity indicator	This LED flashes bright orange when a key is pressed on the remote.
2	Input Selection (0 - 9)	Press these buttons to switch to the desired input (source).
3	Enter	Press this button to commit the routing change.



**NOTE:** An Activity indicator that flashes quickly while holding down any one of the buttons indicates a low battery. Replace the battery as soon as possible. See [Installing the Battery](#).



ID	Name	Description
4	Input	Press this button prior to selecting the input.
5	Output	Press this button prior to selecting the output.
6	Recall	Press this button prior to entering the preset to be loaded.
7	Save	When saving a routing state, press this button prior to entering the preset number.

**Back**

(shown with cover removed)

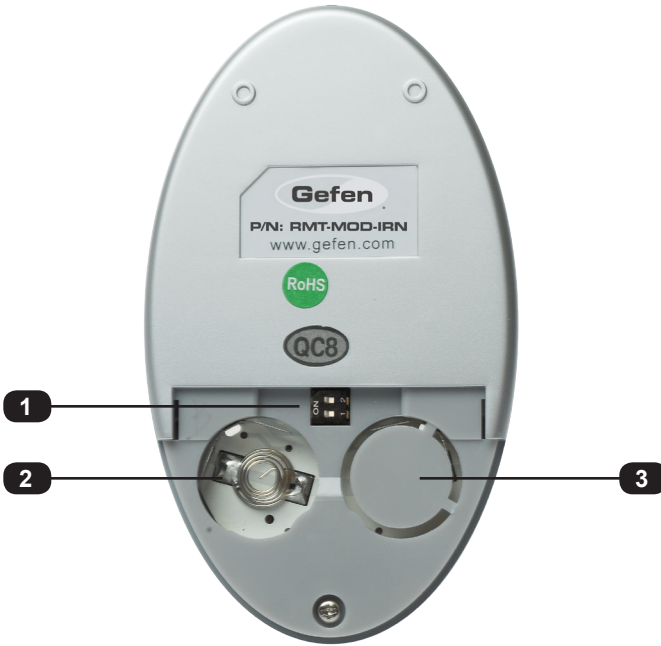

ID	Name	Description
1	DIP switch bank	Use these DIP switches to set the IR channel of the remote. See <a href="#">Setting the IR Channel</a> for more information.
2	Primary battery slot (shown without battery)	Holds the battery for operating the remote. Use only 3V CR2032-type batteries. Make sure that the positive (+) side of the battery is facing up.
3	Alternate battery slot	Allows for the installation of secondary (backup) battery.

## Installing the Battery

The IR remote control unit ships with two batteries. Only one battery is required for operation. The second battery is a spare.



**WARNING:** Use only 3V CR2032-type batteries. Risk of explosion if battery is replaced by an incorrect type. Dispose of used batteries according to the instructions.

1. Remove the back cover the IR Remote Control unit.
2. Insert the included battery into the primary battery slot. The positive (+) side of the battery should be facing up.
3. Replace the back cover.

## Setting the IR Channel

In order for the included IR remote control to communicate with the 16x16 Modular Matrix for HDMI with HDCP, the IR remote control must be set to the same channel as the matrix. Use the `#set_ir` command to set the IR channel of the matrix.



IR Channel	DIP settings
0 (default)	
1	
2	
3	

# Installation

As there are several versions of the 16x16 Modular Matrix for HDMI w/HDCP available, each version will be covered. Locate the connection instructions for the version which was purchased. The wiring diagram at the bottom of the page provides a general reference for connecting the 16x16 Modular Matrix for HDMI w/ HDCP.

- ▶ GEF-HDFST-MOD-16416-HD
- ▶ GEF-HDFST-MOD-16416-HDELRL

## Sample Wiring Diagram

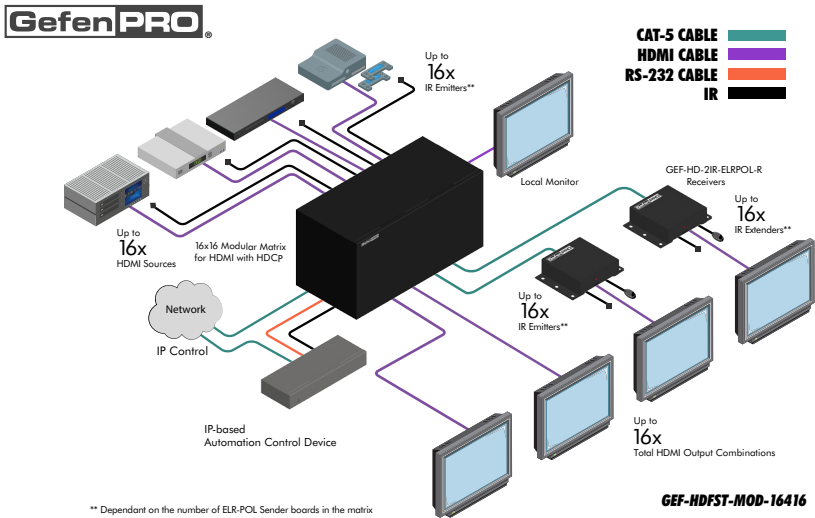

**WARNING:** Both power supplies should always be connected to grounded electrical AC outlets. Each power cord should be connected to an electrical outlet on a separate circuit.

## GEF-HDFST-MOD-16416-HD

1. Connect up to 16 Hi-Def sources to the HDMI inputs on the rear panel of the 16x16 Modular Matrix for HDMI w/ HDCP using HDMI cables.
2. Connect up to 16 HDTV displays to the HDMI outputs on the rear panel of the 16x16 Modular Matrix for HDMI w/ HDCP.
3. Connect both AC power cords from the 16x16 Modular Matrix for HDMI w/ HDCP to available electrical outlets. Connecting both AC power cords will provide redundancy should one of the power supplies fail. It is recommended that each power cord be connected to an electrical outlet on a separate circuit.

## GEF-HDFST-MOD-16416-HDELRL

1. Connect up to 16 Hi-Def sources to the HDMI inputs on the rear panel of the 16x16 Modular Matrix w/ HDCP using HDMI cables.
2. Connect a CAT-5e cable (or better), up to 330 feet (100 meters) from each ELR-POL jack on the Sender card to each of the included ELR-POL Receiver units, as shown below.

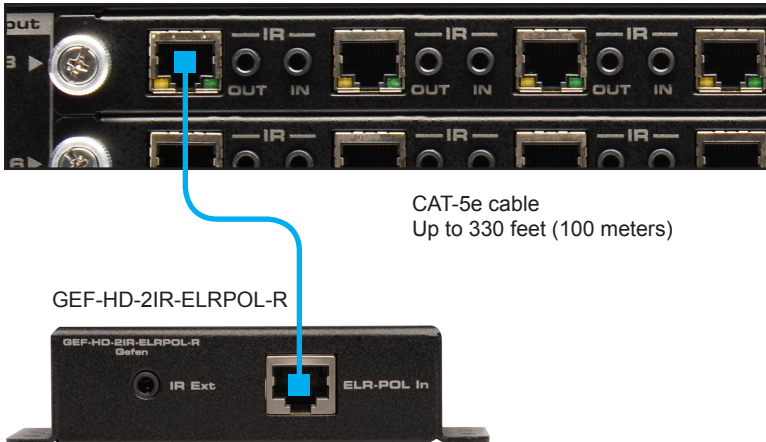

Once the matrix is powered, the Link indicators will glow bright green to indicate a solid link between the output card and the Receiver unit.

The POL indicators will glow bright amber to indicate that the Receiver unit is being powered.

(continued on next page)

3. Connect an HDMI cable from the **HDMI Out** port on each ELR-POL Receiver unit to an HDTV display.

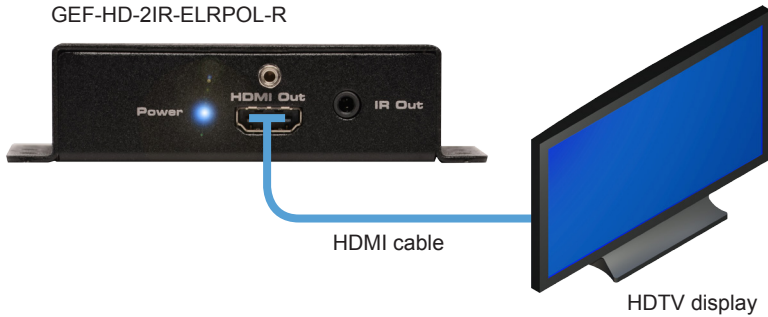

4. Connect both AC power cords from the 16x16 Modular Matrix for HDMI w/ HDCP to available electrical outlets. Connecting both AC power cords will provide redundancy should one of the power supplies fail. It is recommended to connect each power cord to electrical outlets on two separate circuits.

Power to the Receiver unit is delivered from the power supply in the matrix over the CAT-5e cable using Gefen Power Over Line (POL) technology. The Link indicator will glow bright green to indicate a solid connection between the matrix and the Receiver unit. The Power indicator will glow bright blue to indicate that the Receiver unit is being powered.

If either of these LED indicators are OFF, inspect the CAT-5 cable for loose connections or possible defects.







16x16  
sources displays

# Modular Matrix for HDMI with HDCP

## 02 Operating the 16x16 Modular Matrix for HDMI w/ HDCP

Basic Operation .....	16
Standby Mode .....	16
Powering the Matrix .....	16
Accessing the Menu System .....	17
Menu System .....	19
IP Configuration Menu .....	19
Temperature Menu .....	21
LCM Contrast Menu .....	22
Routing Basics .....	23
Displaying the Current Routing Status .....	23
Routing a Source to an Output .....	24
Routing a Source to Multiple Outputs .....	28
Routing a Source to All Outputs .....	30
Saving a Routing Preset .....	32
Recalling a Saved Routing Preset .....	34
Locking the Matrix .....	36
Using Bidirectional IR .....	37
Controlling the Display from the Source Location .....	37
Controlling the Source from the Viewing Location .....	38
Controlling Multiple Sources .....	39
Controlling the Matrix from the Viewing Location .....	40

# Basic Operation

## Standby Mode

After the AC power cord(s) is/are connected to the matrix, the LED indicator next to the display will glow bright blue. The matrix is now in *standby mode*.

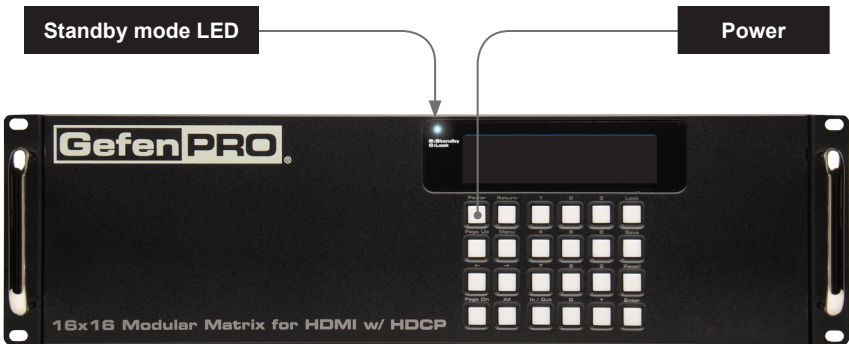

Standby mode is similar to powering-off the matrix. However, in standby mode, the matrix can be powered-on by executing the `#power` command. See [RS-232 and IP Configuration](#) for more information on using the RS-232 / IP commands.

## Powering the Matrix

1. From *standby mode*, press the **Power** button on the front panel.
2. The standby mode LED will turn off.
3. After a few moments, the *home screen* will be displayed:



4. To return to *standby mode*, press the **Power** button on the front panel.

## Accessing the Menu System

The 16x16 Modular Matrix for HDMI w/ HDCP uses a built-in menu system which provides access to other non-routing functions. Use the **Menu** button to access the menu system.

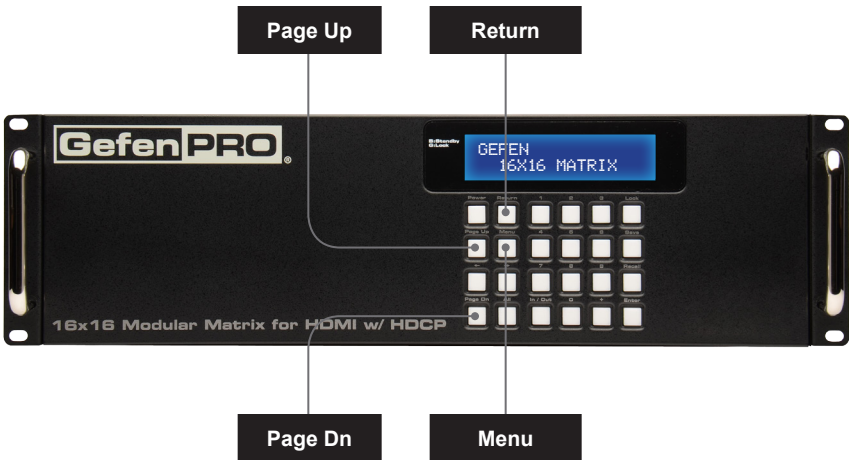

1. From the *home screen*, press the **Menu** button.
2. To cycle through each of the menus, do one of the following:
  - ▶ Consecutively press the **Menu** button. Using the **Menu** button will move forward through each of the menus.
  - ▶ Use the **Page Up** or **Page Dn** buttons. Use the **Page Up** button to go backward through each menu system. Use the **Page Dn** button to go forward through the menu system.
3. Press the **Return** button at any time to return to the *home screen*.



(continued on next page)

Display	Description
1. IP CONFIG	Allows IP configuration for the following: IP address, Net mask, and Gateway address. See <a href="#">RS-232 and IP Configuration</a> for more information.
2. TEMPERATURE	Provides temperature information of the internal boards. See <a href="#">Temperature Menu</a> for more information.
3. LCM CONTRAST	Allows contrast adjustment of the front-panel display. See <a href="#">LCM Contrast Menu</a> for more information.

# Menu System

## IP Configuration Menu

The 16x16 Modular Matrix for HDMI w/ HDCP can be controlled using the built-in Web interface, Telnet, or UDP protocols. In order to use these communication methods, the IP settings of the matrix must be set accordingly. The IP Configuration menu displays the current IP address, net mask, and gateway address for the matrix.



**NOTE:** Depending upon the network, all related IP, Telnet, and UDP settings will need to be assigned. IP settings cannot be changed using the front-panel buttons and must be configured using the RS-232 / IP command set. See [RS-232 and IP Configuration](#) for more information.

1. From the *home screen*, press the **Menu** button. The **IP Config** menu will be displayed.

```
1. IP CONFIG
```



2. Press the **Enter** button to enter the **IP Config** menu. The current IP address of the matrix will be displayed.

```
1A. IP ADDRESS:
192.168.1.239
```

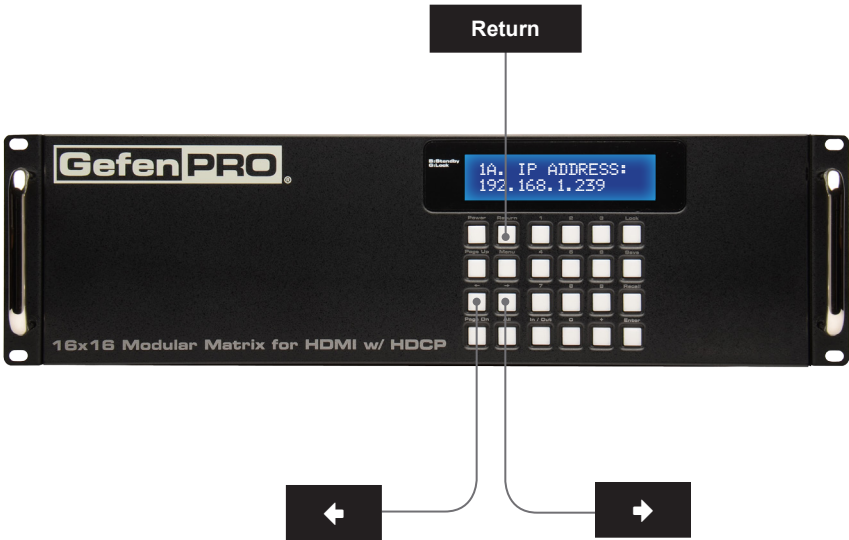

- Press the ← or → button to move backward or forward, respectively, to display the current IP address, net mask, and gateway address of the matrix.



Display	Description
	Displays the current IP address of the matrix. Use the <code>#sipadd</code> command to change the IP address.
	Displays the subnet mask of the matrix. Use the <code>#snetmask</code> command to change the subnet mask.
	Displays the gateway address of the matrix. Use the <code>#sgateway</code> command to change the gateway address.

- Press the **Return** button, twice, to return to the *home screen*.

## Temperature Menu

Temperature data within the enclosure can be reported using the buttons on the front panel.

1. From the *home screen*, press the **Menu** button. The **IP Config** menu will be displayed.



```
1. IP CONFIG
```

2. Consecutively press the **Page Up** or **Page Dn** button until the **Temperature** menu is displayed.



```
2. TEMPERATURE
```

3. Press the **Enter** button to enter the **Temperature** menu. The temperature for each of the internal boards will be displayed.



```
2A. T1: 44.375°C  
T2: 43.250°C
```

4. Press the **Return** button, twice, to return to the *home screen*.



```
GEFEN  
16X16 MATRIX
```

## LCM Contrast Menu

The LCM Contrast Menu is used to adjust the visual intensity (contrast) of the characters in the front-panel display. The contrast can be set to four different levels of intensity. The default value is 4.

1. From the *home screen*, press the **Menu** button. The **IP Config** menu will be displayed.



```
1. IP CONFIG
```

2. Consecutively press the **Page Up** or **Page Dn** button until the **LCM Contrast** menu is displayed.



```
3. LCM CONTRAST
```

3. Press the **Enter** button to enter the **LCM Contrast** menu.



```
3A. CONTRAST:  
RANGE: 1-4
```

4. Enter a number between 1 and 4, using the keypad on the front panel. For example, to set the contrast to 1, press button 1 on front panel. Once the desired button is pressed, the value will appear in the display and the setting will take effect. If another setting is desired, enter a number between 1 and 4 to see the effect.



```
3A. CONTRAST: 1  
RANGE: 1-4
```

5. Press the **Enter** button to accept the changes. The display will indicate "OK".



```
3A. CONTRAST: 1  
RANGE: 1-4  OK
```

6. After a few moments, the *home screen* will be displayed.



## Routing Basics

### Displaying the Current Routing Status

To display the current routing status of the 16x16 Modular Matrix for HDMI w/ HDCP, press the **Page Up** or **Page Dn** buttons.

1. Press the **Page Dn** button on the front panel. The routing status of the first four outputs is displayed.

In the illustration below, we can see that Input 1 is routed to Output 1, Input 7 is routed to Output 2, and so on.

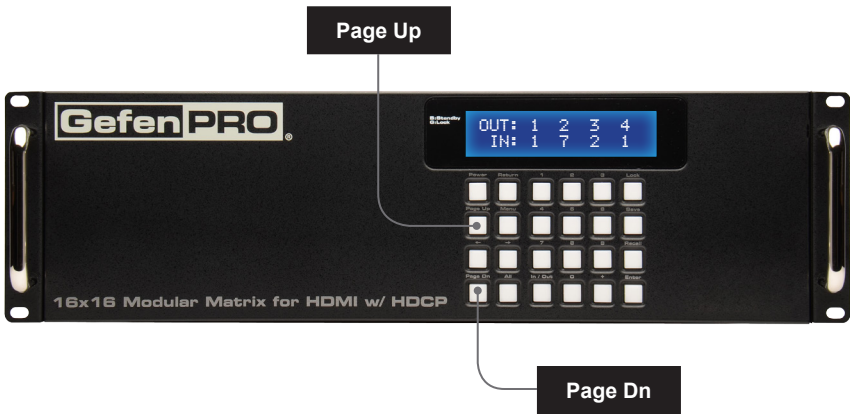

2. Press the **Page Dn** button to view the routing status of the next four inputs / outputs.

```

OUT:  5  6  7  8
IN: 10  4  4  7
  
```

Consecutively press the **Page Dn** button to view the next four outputs. The last item to be displayed will be the routing status of **HDMI Local Out**.

```

OUT: 17 - LOCAL
IN:  3
  
```

## Routing a Source to an Output

### Using the Front Panel Buttons

The following example illustrates how to route a source to an output. An input may be routed to a single or multiple outputs. Multiple inputs cannot be routed to a single output.

1. Press the **In / Out** button on the front panel.



2. The front panel display will indicate that routing mode is active.



3. Select an input (1 - 16) using the numerical keys on the front panel. For this example, we will route Input 15 to Output 12. Enter the input by pressing buttons 1 and 5.



If an incorrect value is entered by accident, use the ← button to delete the last number entered.

4. Press the **In / Out** button, again. The display will change to the following:



```
OUT:  
IN: 15
```

5. Enter the number of the output using the numerical keys on the front panel. Since we want to route Input 15 to Output 12, we will press buttons 1 and 2. The selected output will appear on the display.



```
OUT: 12  
IN: 15
```

Once again, if an incorrect output value is entered by accident, use the ← button to delete the last number entered.

If the decision to change the *input* is made, press the **Return** button to go back to the previous screen. The previous input entry will automatically be erased:



```
PORT SELECT  
IN:
```

6. Once the desired input and output have been entered, press the **Enter** button to execute the routing process. The display will show the following:



```
OK
```

7. After a few moments, the *home screen* will be displayed.



```
GEFEN  
16X16 MATRIX
```

## Using the IR Remote Control

1. Press the **Input** button on the IR remote control.



2. The front panel display will indicate that routing mode is active.



```
PORT SELECT
IN:
```

3. Select an input (1 - 16) using the numerical keys on the IR remote control. For this example, we will route Input 7 to Output 12. Enter the input by pressing button 7.



```
PORT SELECT
IN: 7
```

If an incorrect value is entered by accident, press the **Return** button.

4. Press the **Output** button.



The display will change to the following:

```
OUT:  
IN: 7
```

5. Enter the number of the output using the numerical keys on the IR remote control. Since we want to route Input 7 to Output 12, we will press buttons 1 and 2. The selected output will appear on the display.

```
OUT: 12  
IN: 7
```

If an incorrect output value is entered by accident, press the **Return** button to restart the routing process. Pressing the **Return** button will return the matrix to the home screen.

```
GEFEN  
16X16 MATRIX
```

6. Once the desired input and output have been entered, press the **Enter** button to execute the routing process.



7. After a few moments, the *home screen* will be displayed.

```
GEFEN  
16X16 MATRIX
```

## Routing a Source to Multiple Outputs

The following example illustrates how to route a source to multiple outputs.



**IMPORTANT:** When routing a source to multiple outputs, **HDMI Local Out** (Output 17) is not included as part of the routing process. To route a source to **HDMI Local Out**, it must be performed separately. See [Routing a Source to an Output](#) or [Routing a Source to Multiple Outputs](#).

1. Press the **In / Out** button on the front panel.



2. The front panel display will indicate that routing mode is active.



3. Select an input (1 - 16) using the numerical keys on the front panel.



If an incorrect value is entered by accident, use the ← button to delete the last number entered.

4. Press the **In / Out** button, again. The display will change to the following:



```
OUT:  
IN: 3
```

5. Enter the number of the first output using the numerical keys on the front panel. The selected output will appear on the display.



```
OUT: 12  
IN: 3
```

If an incorrect output value is entered by accident, use the ← button to delete the last number entered.

If the decision to change the *input* is made, press the **Return** button to go back to the previous screen. The previous input entry will automatically be erased:

6. Press the **+** button to add another output.



```
OUT: 12  
IN: 3 3
```

7. Enter the desired output. In the example below, we have entered 4.



```
OUT: 12 4  
IN: 3 3
```

8. Repeat steps 6 and 7 to add more outputs.
9. Press the **Enter** button to complete the routing procedure.
10. After a few moments, the *home screen* will be displayed.



```
GEFEN  
16X16 MATRIX
```

## Routing a Source to All Outputs

The following example illustrates the process for routing a single input to all outputs, simultaneously.

1. Press the **All** button on the front panel.



2. The display on the front panel will show the following:

SWITCH ALL OUT  
TO :

3. Select an input (1 - 16) using the numerical keys on the front panel. For this example, we will route Input 10 to all outputs. Therefore, we'll press buttons 1 and 0.

SWITCH ALL OUT  
TO : 10

If an incorrect value is entered by accident, use the ← button to delete the last number entered.



4. Press the **Enter** button on the front panel.
5. The display will indicate that the routing process was successful.



SWITCH ALL OUT  
TO : 10 OK

6. After a few moments, the *home screen* will be displayed.



GEFEN  
16X16 MATRIX

## Saving a Routing Preset

### Using the Front Panel Buttons

The 16x16 Modular Matrix for HDMI w/ HDCP allows routing (and masking) states to be saved to internal non-volatile memory. Each routing state can be recalled at a later time. Even if the matrix is powered OFF, the presets will be retained in memory.

1. Press the **Save** button on the front panel.



2. The display will show the following:

```
SAVE TO
NO:      (1-8)
```

Save

3. Select a preset (1 - 8) by using the numerical keys on the front panel. For this example, we will save the current routing status to Preset 2 by pressing button **2**.

```
SAVE TO
NO: 2    (1-8)
```

4. Press the **Enter** button to save the current routing state to the preset. The front-panel display will indicate that the preset has been saved.

```
SAVE TO
NO: 2 OK  (1-8)
```

5. After a few moments, the *home screen* will be displayed.

## Using the IR Remote Control

1. Press the **Save** button on the IR remote control.



2. The display will show the following:

```
SAVE TO
NO:      (1-8)
```

3. Select a preset (1 - 8) by using the numerical keys on the IR remote control. For this example, we will save the current routing status to Preset 3 by pressing button **3**.

```
SAVE TO
NO: 3    (1-8)
```

If an incorrect output value is entered by accident, press the **Return** button to restart the process. Pressing the **Return** button will return the matrix to the home screen.

4. Press the **Enter** button to save the current routing state to the preset. The front-panel display will indicate that the preset has been saved.

```
SAVE TO
NO: 3 OK  (1-8)
```

5. After a few moments, the *home screen* will be displayed.

## Recalling a Saved Routing Preset

### Using the Front Panel Buttons

The 16x16 Modular Matrix for HDMI w/ HDCP allows saved routing (and masking) states to be recalled from memory for instant access.

In this example, we will recall the routing preset that we stored in the previous example.

1. Press the **Recall** button on the front panel.



2. The display will show the following:

```

RECALL FROM
NO:          (1-8)
  
```

**Recall**

3. Select a preset (1 - 8) by using the numerical keys on the front panel. For this example, we will recall Preset 3 by pressing button **3**.

```

RECALL FROM
NO: 3       (1-8)
  
```

4. Press the **Enter** button to recall the preset.

```

RECALL FROM
NO: 3 OK   (1-8)
  
```

5. After a few moments, the *home screen* will be displayed.

## Using the IR Remote Control

1. Press the **Recall** button on the IR remote control.



2. The display will show the following:



3. Select a preset (1 - 8) by using the numerical keys on the front panel. For this example, we will recall Preset 3 by pressing button **3**.



If an incorrect output value is entered by accident, press the **Return** button to restart the process. Pressing the **Return** button will return the matrix to the home screen.

4. Press the **Enter** button to recall the preset. The front-panel display will indicate that the preset has been loaded.

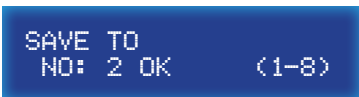

5. After a few moments, the *home screen* will be displayed.

## Locking the Matrix

Locking the matrix will prevent any changes by disabling all buttons (except the **Lock** button) on the front panel. This feature is useful in preventing routing or other changes caused by accidentally bumping or pressing the buttons on the front panel.

1. Press the **Lock** button on the front panel.



2. Once the matrix is locked, the LED indicator next to the display will glow bright green.

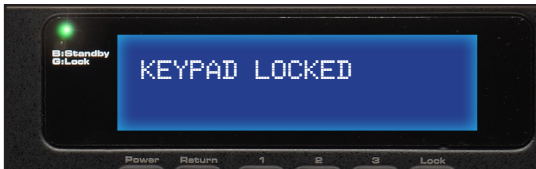

3. To unlock the matrix, press and hold the **Lock** button again, until the LED indicator turns off. The display will return to the *home screen*.



# IR Control

The 16x16 Modular Matrix for HDMI w/ HDCP provides IR control. Use an IR extender (Gefen part no. EXT-RMT-EXTIRN) to control the source device from the viewing location or an automation system to control the display (or other sink device). Refer to the user documentation that came with your automation system for details.

## Controlling the Display from the Source Location



**IMPORTANT:** The IR In ports are designed to accept an electrical IR connection from third-party automation devices. These ports will not work with Gefen IR extenders.

1. Connect the 3.5mm mini-mono end of the IR cable from the **IR IN** port on the matrix to the automation system.
2. Connect an IR emitter (Gefen part no. EXT-IREMIT) from the **IR Out** jack on the Receiver unit to IR sensor on the display.

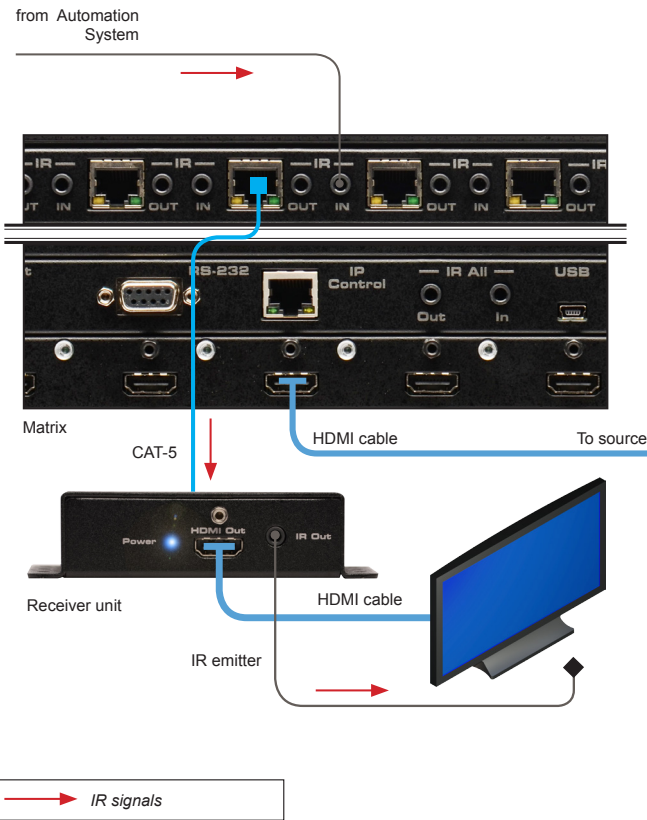

## Controlling the Source from the Viewing Location

 **IMPORTANT:** The **IR Ext** port, on the Receiver unit, is designed to work with the Gefen EXT-RMT-EXTIRN extender. It will not work with the electrical IR connection from an automation control device.

1. Connect an IR extender (Gefen part no. EXT-RMT-EXTIRN) to the **IR Ext** port on the Receiver unit.
2. Connect an IR emitter (Gefen part no. EXT-IREMIT) from the **IR OUT** jack on the 16x16 Modular Matrix for HDMI w/ HDCP to the IR sensor on the source device.

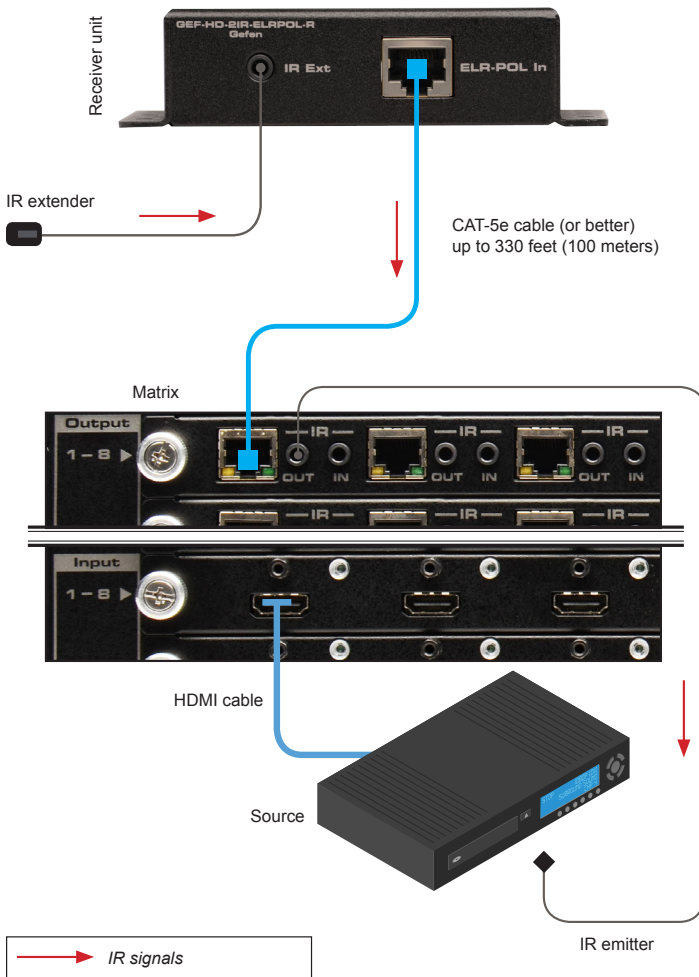





### Controlling Multiple Sources

 **IMPORTANT:** The **IR Ext** port, on the Receiver unit, is designed to work with the Gefen EXT-RMT-EXTIRN extender. It will not work with the electrical IR connection from an automation control device.

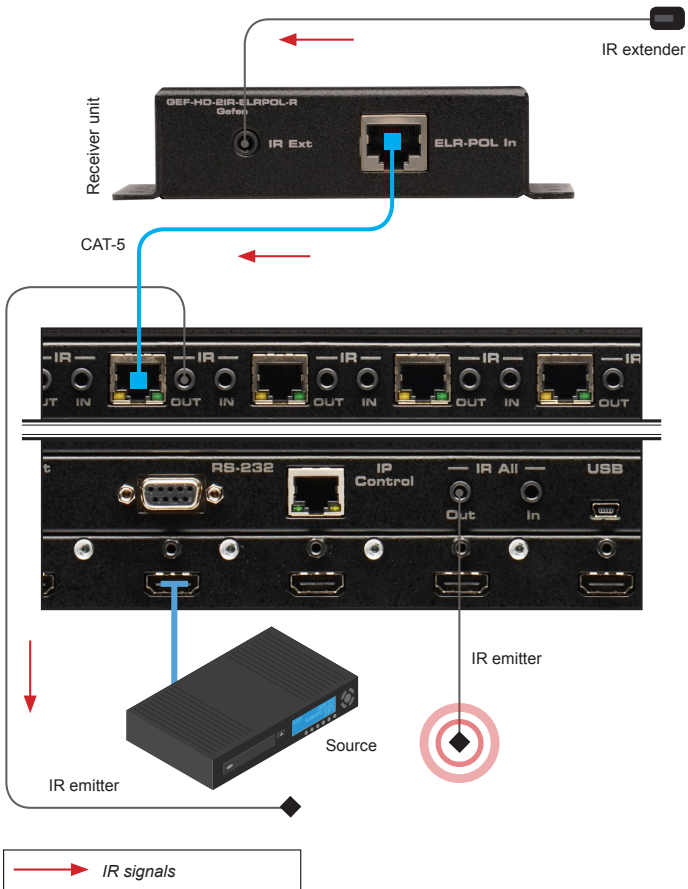
1. Connect an IR extender (Gefen part no. EXT-RMT-EXTIRN) to the **IR Ext** port on the Receiver unit.
2. Connect an IR emitter (Gefen part no. EXT-IREMIT) to the **IR OUT** jack on the 16x16 Modular Matrix for HDMI w/ HDCP.
3. Another IR emitter can be connected to the **IR All Out** port, in order to control individual (or multiple) sources that are not controlled using the IR emitter connected to the **IR OUT** port.



## Controlling the Matrix from the Viewing Location



**IMPORTANT:** The **IR Ext** port, on the Receiver unit, is designed to work with the Gefen EXT-RMT-EXTIRN extender. It will not work with the electrical IR connection from an automation control device.

Routing can be managed from any viewing location, using the included IR remote control unit, regardless of the current routing state of the matrix.

1. Connect an IR extender (Gefen part no. EXT-RMT-EXTIRN) to the **IR Ext** jack on each Receiver unit.
2. Connect an IR emitter (Gefen part no. EXT-IREMIT) from the **IR All Out** port on the back of the matrix and place the emitter over the IR sensor on the front panel of the matrix.

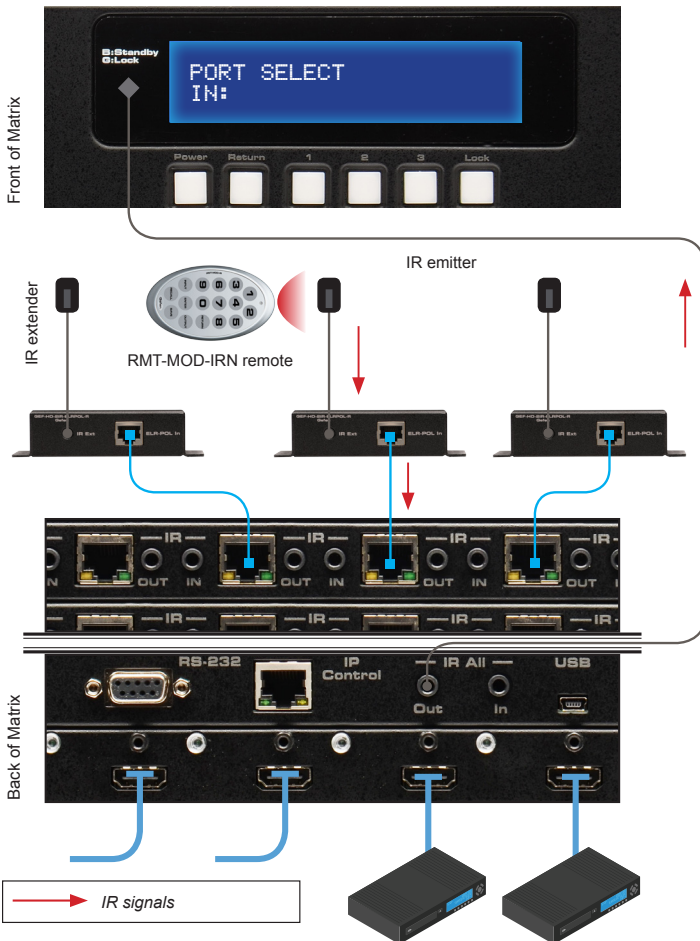





16x16  
sources displays

# Modular Matrix for HDMI with HDCP

## 03 Advanced Operation

RS-232 and IP Configuration .....	44
RS-232 Interface .....	44
RS-232 Settings .....	44
IP / UDP Configuration .....	45
Commands .....	46
IP Configuration .....	46
UDP Configuration .....	57
FST .....	61
Routing and Masking .....	64
System .....	74
Web Interface .....	94
Using the built-in Web Server .....	94
Main ▶ Routing .....	95
Main ▶ I/O Status .....	101
Main ▶ Display Info .....	103
I/O Setup ▶ Preset Names .....	104
I/O Setup ▶ I/O Names .....	105
I/O Setup ▶ HPD Control .....	106
I/O Setup ▶ FST .....	107
I/O Setup ▶ HDCP .....	108
Manage EDID ▶ Assign .....	109
Manage EDID ▶ Bank Names .....	112
Manage EDID ▶ Upload/Download .....	113
Configuration ▶ Change IP Settings .....	114

# RS-232 and IP Configuration

## RS-232 Interface

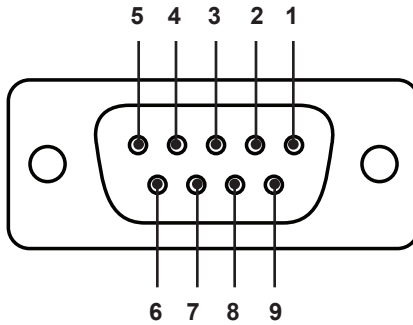

RS-232 Controller

Matrix

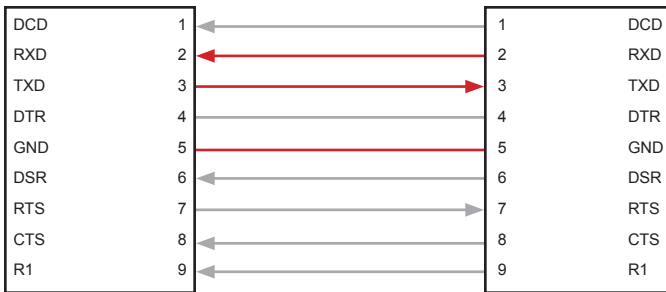

Only TXD, RXD, and GND pins are used.

## RS-232 Settings

Description	Setting
Baud rate	19200
Data bits	8
Parity	None
Stop bits	1
Hardware flow control	None



**IMPORTANT:** When sending RS-232 commands, a carriage return must be included at the end of the command. A space *must* be included between the command and the parameter.

## IP / UDP Configuration

The 16x16 Modular Matrix for HDMI w/ HDCP supports IP-based control using Telnet, UDP, or the built-in Web-based GUI. To set up IP control, the network settings for the 16x16 Modular Matrix for HDMI w/ HDCP must be configured via RS-232. The default network settings for the matrix are as follows:

Description	IP Address / Port	Description	IP Address / Port
IP Address	192.168.1.72	UDP Port	23
Subnet	255.255.255.0	Local UDP Port	50007
Gateway	192.168.1.1	Remote UDP IP	192.168.1.255
HTTP Port	80	Remote UDP Port	50008

1. Connect an RS-232 cable from the PC to the 16x16 Modular Matrix for HDMI w/ HDCP. Also make sure that an Ethernet cable is connected between the matrix and the network.
2. Launch a terminal emulation program (e.g. HyperTerminal) and use the RS-232 settings listed on the previous page.



**NOTE:** Depending upon the network, all related IP, Telnet, and UDP settings will need to be assigned. Consult your network administrator to obtain the proper settings.

3. Set the IP address for the matrix using the `#sipadd` command.
4. Set the subnet mask using the `#snetmask` command.
5. Set the gateway (router) IP address using the `#sgateway` command.
6. Set the Telnet listening port using the `#set_telnet_port` command.
7. Set the HTTP listening port using the `#set_http_port` command.
8. Set the UDP remote IP address for the matrix using the `#set_udp_remote_ip` command.
9. Set the UDP listening port for the matrix using the `#set_udp_port` command.
10. Set the UDP remote port for the matrix using the `#set_udp_remote_port` command.
11. Reboot the matrix to apply all changes, then type the IP address that was specified in step 3, in a Web browser to access the Web GUI. Use the same IP address to Telnet to the matrix.

# Commands

## IP Configuration

Command	Description
<code>#display_telnet_welcome</code>	Enable / disable the Telnet welcome message
<code>#ipconfig</code>	Displays the current IP configuration
<code>#resetip</code>	Resets the IP configuration to factory-default settings
<code>#set_http_port</code>	Sets the Web server listening port
<code>#set_telnet_pass</code>	Sets the Telnet password
<code>#set_telnet_port</code>	Sets the Telnet listening port for the matrix
<code>#set_webui_ad_pass</code>	Sets the Administrator password for the Web GUI
<code>#set_webui_op_pass</code>	Sets the Operator password for the Web GUI
<code>#sgateway</code>	Sets the IP address of the (router) gateway
<code>#show_gateway</code>	Displays the current gateway address of the matrix
<code>#show_http_port</code>	Displays the current HTTP listening port of the matrix
<code>#show_ip</code>	Displays the current IP address of the matrix
<code>#show_mac_addr</code>	Displays the MAC address of the matrix
<code>#show_netmask</code>	Displays the current net mask of the matrix
<code>#show_telnet_port</code>	Displays the Telnet listening port
<code>#sipadd</code>	Sets the IP address of the matrix
<code>#snetmask</code>	Sets the Net mask of the matrix
<code>#use_telnet_pass</code>	Force password during Telnet sessions



## #display\_telnet\_welcome

The #display\_telnet\_welcome command enables / disables the Telnet welcome message during a Telnet session.

### Syntax:

```
#display_telnet_welcome
```

### Parameters:

*param1* Value [0 ... 1]

Value	Description
0	Disable welcome message
1	Enable welcome message

### Example:

```
#display_telnet_welcome 1  
TELNET WELCOME SCREEN IS ENABLED
```

When enabled and a Telnet session has been started, the following will appear:

```
Welcome to GEF-HDFST-MOD-16416 TELNET  
telnet->
```

## #ipconfig

The #ipconfig command displays the current TCP settings.

**Syntax:**

```
#ipconfig
```

**Parameters:**

None

**Example:**

```
#ipconfig
IP Configuration is :

IP: 192.168.2.238
NETMASK: 255.255.255.0
GATEWAY: 192.168.2.1
MAC Address: 00-1c-91-03-00-04
```

## #resetip

The #resetip command resets the IP configuration to factory-default settings. The matrix must be rebooted after executing this command.

**Syntax:**

```
#resetip
```

**Parameters:**

None

**Syntax:**

```
#resetip

IP CONFIGURATION WAS RESET TO FACTORY DEFAULTS
IP: 192.168.1.72
Netmask: 255.255.255.0
Gateway: 192.168.1.1
```

## #set\_http\_port

The `#set_http_port` command specifies the Web server listening port. The matrix must be rebooted after executing this command. The default port setting is 80. Use the `#show_http_port` command to display the current HTTP listening port.

### Syntax:

```
#set_http_port param1
```

### Parameters:

<i>param1</i>	Port	[1 ... 1024]
---------------	------	--------------

### Example:

```
#set_http_port 82
```

```
HTTP COMMUNICATION PORT 82 IS SET. PLEASE REBOOT THE UNIT.
```

## #set\_telnet\_pass

The `#set_telnet_pass` command sets the Telnet password. The password is case-sensitive and cannot exceed 8 characters in length. The default password is Admin.

### Syntax:

```
#set_telnet_pass param1
```

### Parameters:

<i>param1</i>	Password
---------------	----------

### Example:

```
#set_telnet_pass 3ver3st
```

```
TELNET INTERFACE PASSWORD IS SET
```

## #set\_telnet\_port

The #set\_telnet\_port command sets the Telnet listening port. The matrix must be rebooted after executing this command. The default port setting is 23. Use the #show\_telnet\_port command to display the current Telnet listening port.

### Syntax:

```
#set_telnet_port param1
```

### Parameters:

<i>param1</i>	Port	[1 ... 1024]
---------------	------	--------------

### Example:

```
#set_telnet_port 24
```

```
TELNET COMMUNICATION PORT 24 IS SET. PLEASE REBOOT THE UNIT.
```

## #set\_webui\_ad\_pass

The #set\_webui\_ad\_pass command sets the Administrator password for the Web GUI. The password is case-sensitive and cannot exceed 7 characters in length. The default password is Admin.

### Syntax:

```
#set_webui_ad_pass param1
```

### Parameters:

<i>param1</i>	Password
---------------	----------

### Example:

```
#set_webui_ad_pass bossman
```

```
WEB UI ADMINISTRATOR PASSWORD IS SET
```

## #set\_webui\_op\_pass

The #set\_webui\_ad\_pass command sets the Operator password for the Web GUI. The default password is Admin.

### Syntax:

```
#set_webui_op_pass param1
```

### Parameters:

*param1* Password

### Example:

```
#set_webui_op_pass minion  
WEB UI OPERATOR PASSWORD IS SET
```

## #sgateway

The #sgateway command sets the gateway address. The gateway must be typed using dot-decimal notation. The matrix must be rebooted after executing this command. The default gateway is 192.168.1.1.

### Syntax:

```
#sgateway param1
```

### Parameters:

*param1* Gateway

### Example:

```
#sgateway 192.168.1.5  
GATEWAY ADDRESS 192.168.1.5 IS SET. PLEASE REBOOT THE UNIT.
```

## #show\_gateway

The #show\_gateway command displays the current gateway address of the matrix. Use the #sgateway command to set the gateway address.

### Syntax:

```
#show_gateway
```

### Parameters:

None

### Example:

```
#show_gateway
```

```
GATEWAY ADDRESS IS: 192.168.1.5
```

## #show\_http\_port

The #show\_http\_port command displays the current HTTP listening port of the matrix. Use the #set\_http\_port command to set the HTTP listening port.

### Syntax:

```
#show_http_port
```

### Parameters:

None

### Example:

```
#show_http_port
```

```
HTTP COMMUNICATION PORT IS: 82
```

## #show\_ip

The #show\_ip command displays the current IP address of the matrix. Use the #sipadd command to set the IP address.

### Syntax:

```
#show_ip
```

### Parameters:

None

### Example

```
#show_ip
```

```
IP ADDRESS IS: 192.168.1.239
```

## #show\_mac\_addr

The #show\_mac\_addr command displays the MAC address of the matrix.

### Syntax:

```
#show_mac_addr
```

### Parameters:

None

### Example:

```
#show_mac_addr
```

```
MAC ADDRESS IS: 00-1c-91-03-00-02
```

## #show\_netmask

The #show\_netmask command displays the current net mask of the matrix. Use the #snetmask command to set the net mask.

### Syntax:

```
#show_netmask
```

### Parameters:

None

### Example:

```
#show_netmask
```

```
NETMASK ADDRESS IS: 255.255.255.0
```

## #show\_telnet\_port

The #show\_telnet\_port command displays the current Telnet port of the matrix. Use the #set\_telnet\_port command to set the Telnet listening port.

### Syntax:

```
#set_telnet_port param1
```

### Parameters:

<i>param1</i>	Port	[1 ... 65535]
---------------	------	---------------

### Example:

```
#set_telnet_port 24
```

```
TELNET COMMUNICATION PORT 24 IS SET. PLEASE REBOOT THE UNIT.
```



## #sipadd

The #sipadd command sets the IP address of the matrix. The IP address must be entered using dot-decimal notation. The matrix must be rebooted after executing this command. The default IP address is 192.168.1.72. Use the #show\_ip or #ipconfig command to display the current IP address of the matrix.

### Syntax:

```
#sipadd param1
```

### Parameters:

*param1*                                  IP address

### Example:

```
#sipadd 192.168.1.239
```

```
IP ADDRESS 192.168.1.239 IS SET. PLEASE REBOOT THE UNIT.
```

## #snetmask

The #snetmask command sets the subnet mask. The net mask must be entered using dot-decimal notation. The matrix must be rebooted after executing this command. The default net mask is 255.255.255.0. Use the #show\_netmask command to display the current net mask of the matrix.

### Syntax:

```
#snetmask param1
```

### Parameters:

*param1*                                  Net mask

### Example:

```
#snetmask 255.255.0.0
```

```
NETMASK ADDRESS 255.255.0.0 IS SET. PLEASE REBOOT THE UNIT.
```

## #use\_telnet\_pass

The #use\_telnet\_pass command forces the password credentials for each Telnet session. The default setting is 0 (disabled).

### Syntax:

```
#use_telnet_pass param1
```

### Parameters:

*param1* Value [0 ... 1]

Value	Description
0	Disable password
1	Enable password

### Example:

```
#use_telnet_pass 1
```

```
TELNET INTERACE PASSWORD IS ENABLED
```

## UDP Configuration

Command	Description
<code>#set_udp_port</code>	Sets the local UDP listening port
<code>#set_udp_remote_ip</code>	Sets the remote UDP IP address
<code>#set_udp_remote_port</code>	Sets the remote UDP listening port
<code>#show_udp_port</code>	Displays the current local UDP listening port
<code>#show_udp_remote_ip</code>	Displays the current remote UDP IP address
<code>#show_udp_remote_port</code>	Displays the current remote UDP listening port
<code>#use_udp_enable</code>	Enables / disables UDP access

### #set\_udp\_port

The `#set_udp_port` command sets the local UDP server listening port. The default port setting is 21. The matrix must be rebooted after executing this command. Use the `#show_udp_port` command to display the current local UDP listening port.

#### Syntax:

```
#set_udp_port param1
```

#### Parameters:

*param1*                              Port                              [1 ... 65535]

#### Example:

```
#set_udp_port 56
```

```
UDP COMMUNICATION PORT 56 IS SET
```

## #set\_udp\_remote\_ip

The #set\_udp\_remote\_ip command sets the remote UDP IP address. The IP address must be specified using dot-decimal notation. The default UDP remote IP address is 192.168.1.255. The matrix must be rebooted after executing this command.

### Syntax:

```
#set_udp_remote_ip param1
```

### Parameters:

*param1*                                 UDP address

### Example:

```
#set_udp_remote_ip 192.168.1.227
```

```
REMOTE UDP IP ADDRESS 192.168.1.227 IS SET.
```

## #set\_udp\_remote\_port

The #set\_udp\_remote\_port command sets the remote UDP listening port. The default remote UDP listening port is 50008. The matrix must be rebooted after executing this command.

### Syntax:

```
#set_udp_rport param1
```

### Parameters:

*param1*                                 Port                                 [1 ... 65535]

### Example:

```
#set_udp_rport 50008
```

```
REMOTE UDP COMMUNICATION PORT 50008 IS SET.
```

## #show\_udp\_port

The #show\_udp\_port command displays the current local UDP listening port. Use the #set\_udp\_port command to set the local UDP listening port.

### Syntax:

```
#show_udp_port
```

### Parameters:

None

### Example:

```
#show_udp_port
```

```
UDP COMMUNICATION PORT IS: 56
```

## #show\_udp\_remote\_ip

The #show\_udp\_remote\_ip command displays the remote UDP IP address. Use the #set\_udp\_remote\_ip command to set the remote UDP IP address.

### Syntax:

```
#set_udp_remote_ip param1
```

### Parameters:

None

### Example:

```
#set_udp_remote_ip 192.168.1.227
```

```
REMOTE UDP IP ADDRESS 192.168.1.227 IS SET.
```

## #show\_udp\_remote\_port

The #show\_udp\_remote\_port command displays the remote UDP listening port. Use the #set\_udp\_remote\_port to set the remote UDP listening port.

### Syntax:

```
#set_udp_rport param1
```

### Parameters:

None

### Example:

```
#show_udp_remote_port
REMOTE UDP COMMUNICATION PORT IS: 50008
```

## #use\_udp\_enable

The #use\_udp\_enable command enables or disables UDP access mode.

### Syntax:

```
#use_udp_enable param1
```

### Parameters:

*param1* Value [0 ... 1]

Value	Description
0	Disable UDP
1	Enable UDP

### Example:

```
#use_udp_enable 1
UDP ACCESS IS ENABLE
```

## FST

Command	Description
<code>#fst_fast</code>	Sets the specified inputs to Fast switching mode
<code>#fst_slow</code>	Sets the specified inputs to Slow switching mode
<code>#show_fst</code>	Displays the current switching mode for the specified input

### **#fst\_fast**

The `#fst_fast` command sets the specified inputs to Fast switching mode. By default, all inputs are set to Fast switching mode. Up to 16 inputs can be specified at a time. If `param1 = 0`, then all inputs are set to Fast switching mode.

#### Syntax:

```
#fst_fast param1 [...param16]
```

#### Parameters:

*param1*    Input    [1 ... 16]

#### Examples:

```
#fst_fast 1 4 5 6 10 12
```

```
INPUTS 1, 4, 5, 6, 10, 12 ARE SET TO FST FAST MODE
```

```
#fst_fast 0
```

```
ALL INPUTS ARE SET TO FST FAST MODE
```

## #fst\_slow

The #fst\_slow command sets the specified inputs to Slow (normal) switching mode. Up to 16 inputs can be specified at a time. If *param1* = 0, then all inputs are set to Slow switching mode.

### Syntax:

```
#fst_slow param1 [...param16]
```

### Parameters:

<i>param1</i>	Input	[1 ... 16]
---------------	-------	------------

### Examples:

```
#fst_slow 1 2 4 7 8 9 10 12
```

```
INPUTS 1, 2, 4, 7, 8, 9, 10, 12 ARE SET TO FST SLOW MODE
```

```
#fst_slow 0
```

```
ALL INPUTS ARE SET TO FST SLOW MODE
```



## #show\_fst

The #show\_fst command displays the switching mode of the specified input. If *param1* = 0, then the switching mode of all inputs are displayed.

### Syntax:

```
#show_fst param1
```

### Parameters:

<i>param1</i>	Input	[1 ... 16]
---------------	-------	------------

### Examples:

```
#show_fst 6
```

```
INPUT 6(Input6) IS IN FAST SWITCHING MODE
```

```
#show_fst 0
```

```
INPUT 1(Input1) IS IN SLOW SWITCHING MODE
INPUT 2(Input2) IS IN FAST SWITCHING MODE
INPUT 3(Input3) IS IN FAST SWITCHING MODE
INPUT 4(Input4) IS IN SLOW SWITCHING MODE
INPUT 5(Input5) IS IN SLOW SWITCHING MODE
INPUT 6(Input6) IS IN SLOW SWITCHING MODE
INPUT 7(Input7) IS IN FAST SWITCHING MODE
INPUT 8(Input8) IS IN FAST SWITCHING MODE
INPUT 9(Input9) IS IN FAST SWITCHING MODE
INPUT 10(Input10) IS IN SLOW SWITCHING MODE
INPUT 11(Input11) IS IN FAST SWITCHING MODE
INPUT 12(Input12) IS IN FAST SWITCHING MODE
INPUT 13(Input13) IS IN FAST SWITCHING MODE
INPUT 14(Input14) IS IN FAST SWITCHING MODE
INPUT 15(Input15) IS IN SLOW SWITCHING MODE
INPUT 16(Input16) IS IN FAST SWITCHING MODE
```

## Routing and Masking

Command	Description
#mask	Masks the video on the specified output(s)
#recall_preset	Loads the specified routing / masking preset
#save_preset	Saves the current routing / masking state to a preset
#set_bank_name	Assigns an EDID bank with the specified name
#set_input_name	Assigns an input with the specified name
#set_output_name	Assigns an output with the specified name
#set_preset_name	Assigns a preset with the specified name
#show_bank_name	Displays the name for the specified EDID bank
#show_input_name	Displays the specified input name
#show_mask	Displays the current masking status of each output
#show_output_name	Displays the name of the specified output
#show_preset_name	Displays the specified preset name
#unmask	Unmasks the specified outputs
r	Routes the specified input to the specified outputs
s	Routes the specified input to all outputs

### #mask

The #mask command masks the video on the specified outputs. If *param1* = 0, then all outputs will be masked. Output 17 is **HDMI Local Out**.

#### Syntax:

```
#mask param1 [...param17]
```

#### Parameters:

*param1*                      Output                      [1 ... 17]

#### Example:

```
#mask 1 3 5 7 11
```

OUTPUTS 1, 3, 5, 7, 11 ARE MASKED

## #recall\_preset

The #recall\_preset command loads the specified preset. Use the #save\_preset command to store a preset.

### Syntax:

```
#recall_preset param1
```

### Parameters:

<i>param1</i>	Preset	[1 ... 8]
---------------	--------	-----------

### Example:

```
#recall_preset 7
```

```
RECALLED THE ROUTING STATE SAVED TO PRESET 7
```

## #save\_preset

The #save\_preset command saves the current routing / masking state to the specified preset. Use the #recall\_preset command to load a preset.

### Syntax:

```
#save_preset param1
```

### Parameters:

<i>param1</i>	Preset	[1 ... 8]
---------------	--------	-----------

### Example:

```
#save_preset 3
```

```
CURRENT ROUTING STATE IS SAVED TO PRESET 3
```

## #set\_bank\_name

The #set\_bank\_name command names the specified bank.

### Syntax:

```
#set_bank_name param1 param2
```

### Parameters:

<i>param1</i>	Bank	[1 ... 8]
<i>param2</i>	Name	

### Example:

```
#set_bank_name 5 Dell_30
```

```
Dell_30 NAME IS ASSIGNED TO BANK 5
```

## #set\_input\_name

The #set\_input\_name command assigns a name to the specified input on the matrix.

### Syntax:

```
#set_input_name param1 param2
```

### Parameters:

<i>param1</i>	Input	[1 ... 16]
<i>param2</i>	Name	

### Example:

```
#set_input_name 5 Blu-ray
```

```
Blu-ray NAME IS ASSIGNED TO INPUT 5
```

## #set\_output\_name

The #set\_output\_name command assigns a name to the specified output on the matrix. Output 17 is **HDMI Local Out**.

### Syntax:

```
#set_output_name param1 param2
```

### Parameters:

<i>param1</i>	Output	[1 ... 17]
<i>param2</i>	Name	

### Example:

```
#set_output_name 3 Sony_XBR
Sony_XBR NAME IS ASSIGNED TO OUTPUT 3
```

## #set\_preset\_name

The #set\_preset\_name command names the specified preset. The name of the preset cannot exceed 20 characters in length. Spaces are not permitted when naming presets. If a space is required, then use the underscore (“\_”) character.

### Syntax:

```
#set_preset_name param1 param2
```

### Parameters:

<i>param1</i>	Preset	[1 ... 8]
<i>param2</i>	Name	

### Example:

```
#set_preset_name 8 Studio51
Studio51 NAME IS ASSIGNED TO PRESET 8
```

## #show\_bank\_name

The #show\_bank\_name command displays the name for the specified EDID bank.

### Syntax:

```
#show_bank_name param1
```

### Parameters:

<i>param1</i>	Bank	[1 ... 8]
---------------	------	-----------

### Example:

```
#show_bank_name 5  
THE NAME FOR BANK 2 IS: Dell_30
```

## #show\_input\_name

The #show\_input\_name command displays the name of the specified input.

### Syntax:

```
#show_input_name param1
```

### Parameters:

<i>param1</i>	Input	[1 ... 16]
---------------	-------	------------

### Example:

```
#show_input_name 5  
THE NAME FOR INPUT 5 IS: Blu-ray
```

## #show\_mask

The #show\_mask command displays the mask status of the specified output. Output 17 is **HDMI Local Out**.

### Syntax:

```
#show_mask param1
```

### Parameters:

<i>param1</i>	Output	[1 ... 17]
---------------	--------	------------

### Example:

```
#show_mask 15  
OUTPUT 15 IS UNMASKED
```

## #show\_output\_name

The #show\_output\_name command displays the name of the specified output. Output 17 is **HDMI Local Out**.

### Syntax:

```
#show_output_name param1
```

### Parameters:

<i>param1</i>	Output	[1 ... 17]
---------------	--------	------------

### Example:

```
#show_output_name 3  
THE NAME FOR OUTPUT 3 IS: Sony_XBR
```

## #show\_preset\_name

The #show\_preset\_name command displays the name of the specified preset.

### Syntax:

```
#show_preset_name param1
```

### Parameters:

<i>param1</i>	Preset	[1 ... 8]
---------------	--------	-----------

### Example:

```
#show_preset_name 8
```

```
THE NAME FOR PRESET 8 IS: Studio51
```



## #unmask

The #unmask command unmask the specified output(s). Up to 16 outputs can be specified at a time. If *param1* = 0, then all outputs will be unmasked. Output 17 is **HDMI Local Out**.

### Syntax:

```
#unmask param1 [... param17]
```

### Parameters:

<i>param1</i>	Output	[1 ... 17]
---------------	--------	------------

### Examples:

```
#unmask 3
```

```
OUTPUT 3 IS UNMASKED
```

```
#unmask 1 3 5 6 7
```

```
OUTPUTS 1, 3, 5, 6, 7 ARE UNMASKED
```

```
#unmask 0
```

```
ALL OUTPUTS ARE UNMASKED
```

**r**

The `r` command routes the specified input to the specified outputs. Up to eight outputs can be specified at a time. Do not precede this command with the “#” symbol. If `param2 = 0`, then the specified input will be routed to all outputs. Output 17 is **HDMI Local Out**. Also see the `s` command.

Syntax:

```
r param1 param2 [... param17]
```

Parameters:

<code>param1</code>	Input	[1 ... 16]
<code>param2</code>	Output	[1 ... 17]

Example:

```
r 1 2 3 7 8 9
```

```
INPUT 1 IS SET TO OUTPUTS 2, 3, 7, 8, 9
```

```
r 5 0
```

```
INPUT 5 IS SET TO ALL OUTPUTS.
```

**S**

The `s` command routes the specified inputs to all outputs. Do not precede this command with the “#” symbol. If *param1* = 0, then the matrix will be placed in a 1-to-1 routing state. In other words, Input 1 is routed to Output 1, Input 2 is routed to Output 2, and so on.

**Syntax:**

```
s param1
```

**Parameters:**

<i>param1</i>	Input	[1 ... 16]
---------------	-------	------------

**Example:**

```
s 2
```

```
ALL OUTPUTS ARE ROUTED TO INPUT 2
```

```
s 0
```

```
Routing 1-1,2-2,...
```

## System

Command	Description
#echo	Enables / disables RS-232 feedback
#fadefault	Resets the routing and masking to factory-default settings
#hdcp	Enables / disables HDCP detection
#help	Displays a list of available RS-232 / Telnet commands
#hdp_pulse	Cycles with HPD line on the specified output
#lock_edid	Locks the local EDID when the matrix is power-cycled
#lock_matrix	Locks / unlocks the matrix
#power	Toggles the power on the matrix
#reboot	Reboots the matrix
#set_edid	Sets the specified EDID to an input or bank
#set_ir	Sets the IR channel for the matrix
#show_fw	Displays the current version of matrix firmware
#show_hdcp	Displays the HDCP status of the specified input
#show_hpd	Displays the HPD status of the specified input
#show_ir	Displays the current IR channel of the matrix
#show_out_colordpt	Displays the maximum color depth supported by the display (sink) device based on the EDID
#show_out_res	Displays the maximum video resolution supported by the display (sink) device, based on the EDID
#show_r	Displays the current routing status of the specified output
#show_rsense	Displays the RSENSE status of the specified output
#show_ver_data	Displays the current firmware and hardware version
m	Displays the current matrix routing status
n	Displays the routing status of the specified output

## #echo

The #echo command enables / disables (toggles) the RS-232 feedback.

### Syntax:

```
#echo param1
```

### Parameters:

*param1* Value [0 ... 1]

Value	Description
0	Disable feedback
1	Enable feedback

### Example:

```
#echo 1
```

```
LOCAL ECHO IS ON
```

## #fadefault

The #fadefault command resets the matrix to factory-default settings. Routing is restored to a "one-to-one" state, outputs are unmasked, and all IP and UDP settings are reset to default settings.

### Syntax:

```
#fadefault
```

### Parameters:

None

### Example:

```
#fadefault

MATRIX WAS RESET TO FACTORY DEFAULTS
MATRIX IS ON
MATRIX IS UNLOCKED
LOCAL ECHO IS ON
ALL OUTPUTS ARE UNMASKED
SET HPD HIGH TO ALL INPUT
IP ADDRESS IS: 192.168.1.72
GATEWAY ADDRESS IS: 192.168.1.1
NET MASK ADDRESS IS: 255.255.255.0
...
...
...
INPUT NAME INIT....
OUTPUT NAME INIT....
PRESET NAME INIT....
BANK NAME INIT....
BANK EDID INIT....
BASE EDID INIT....
CURRENT ROUTING STATE IS SAVED TO PRESET 1
CURRENT ROUTING STATE IS SAVED TO PRESET 2
CURRENT ROUTING STATE IS SAVED TO PRESET 3
CURRENT ROUTING STATE IS SAVED TO PRESET 4
CURRENT ROUTING STATE IS SAVED TO PRESET 5
CURRENT ROUTING STATE IS SAVED TO PRESET 6
CURRENT ROUTING STATE IS SAVED TO PRESET 7
CURRENT ROUTING STATE IS SAVED TO PRESET 8
IR CHANNEL IS SET TO CHANNEL 0 (DIP1=OFF, DIP2=OFF)
ALL INPUTS HDCP ARE ENABLED
ALL INPUTS ARE SET TO FST FAST MODE
MATRIX EDID IS UNLOCKED
MATRIX WILL REBOOT SHORTLY *REBOOT UNIT IN 2 SECONDS
```

## #hdcp

The #hdcp command enables / disables HDCP detection on the selected input.



**NOTE:** Some computers will enable HDCP if an HDCP-compliant display is detected. Set *param2* = 1 to force the computer to ignore detection of an HDCP-compliant display. Setting *param2* = 0 does **not** decrypt HDCP content.

### Syntax:

```
#hdcp param1 param2
```

### Parameters:

<i>param1</i>	Input	[1 ... 16]
<i>param2</i>	Value	[0 ... 1]

Value	Description
0	Disable
1	Enable

### Example:

```
#hdcp 2 0
INPUT 2 HDCP IS DISABLED
```

```
#hdcp 2 1
INPUT 2 HDCP IS ENABLED
```

## #help

The #help command displays the list of available RS-232 / Telnet commands. Help on a specific command can be displayed when using `param1`.

### Syntax:

```
#help param1
```

### Parameters:

`param1` Command name (optional)

### Examples:

```
#help
```

```
=====
```

```
#IPCONFIG
#RESETIP
#SIPADD
#SNETMASK
#SGATEWAY
#SHOW_IP
#SHOW_NETMASK
#SHOW_GATEWAY
#SHOW_MAC_ADDR
#SET_HTTP_PORT
#SHOW_HTTP_PORT
...
...
...
#FST_FAST
#SHOW_FST
#STRTO_IN
```

```
=====
```

```
#help #sipadd
```

```
#SIPADD PARAM 1
SET THE IP ADDRESS
PARAM 1 = XXX.XXX.XXX.XXX
WHERE XXX: 0 - 255
```



## #hdp\_pulse

The #hdp\_pulse command cycles the HPD line on the specified input. Issuing this command is identical to physically disconnecting and reconnecting the cable between the source and the matrix. If param1 = 0, then all inputs will receive the HPD pulse.

### Syntax:

```
#hdp_pulse param1
```

### Parameters:

<i>param1</i>	Input	[1 ... 16]
---------------	-------	------------

### Examples:

```
#hdp_pulse  
HPD PULSE HAS BEEN SENT TO INPUT 1
```

```
#hdp_pulse 0  
HPD PULSE HAS BEEN SENT TO ALL INPUTS
```

## #lock\_edid

The #lock\_edid command secures the Local EDID by disabling the automatic loading of the downstream EDID when the matrix is powered.

### Syntax:

```
#lock_edid param1
```

### Parameters:

*param1* Value [0 ... 1]

Value	Description
0	Disable
1	Enable

### Examples:

```
#lock_edid 0  
MATRIX EDID IS UNLOCKED
```

```
#lock_edid 1  
MATRIX EDID IS LOCKED
```

## #lock\_matrix

The #lock\_matrix command locks / unlocks the Matrix. When the matrix is locked, all functions are disabled including the front panel, RS-232, and Telnet

### Syntax:

```
#lock_matrix param1
```

### Parameters:

*param1* Value [0 ... 1]

Value	Description
0	Unlock
1	Lock

### Examples:

```
#lock_matrix 0  
MATRIX IS UNLOCKED
```

```
#lock_matrix 1  
MATRIX IS LOCKED
```

## #power

The `#power` command toggles power on the matrix.

### Syntax:

```
#power param1
```

### Parameters:

*param1* Value [0 ... 1]

Value	Description
0	Off
1	On

### Examples:

```
#power 0  
(matrix will power-off)
```

```
#power 1  
(matrix will power-on)
```

## #reboot

The `#reboot` command reboots the matrix. Executing this command is the equivalent of disconnecting and reconnecting the AC power cord, on the back of the matrix. The matrix must be rebooted after changing the IP settings of the matrix.

### Syntax:

```
#reboot
```

### Parameters:

*None*

### Example:

```
#reboot
```

```
MATRIX WILL REBOOT SHORTLY *REBOOT UNIT IN 2 SECONDS
```

```
GEF-HDFST-MOD-16416 v1.0X
```

```
MATRIX IS ON  
INPUT 3 IS SET TO ALL OUTPUTS.
```

```
IP: 192.168.2.239  
Netmask: 255.255.255.0  
Gateway: 192.168.1.1
```

## #set\_edid

The #set\_edid command sets the specified EDID type to an input or bank. Output 17, used by *param2*, is **HDMI Local Out**.

### Syntax:

```
#set_edid param1 param2 param3 param4
```

### Parameters:

*param1* Source [STRING]

Source	Description
default	Uses default EDID
dynamic	Uses dynamic EDID
bank	Uses EDID bank
output	Uses EDID on Output (sink)

*param2* Source [0 ... 17]

Source	Description
0	Default EDID
1 ... 8	EDID bank
1 ... 17	Output

*param3* Target [STRING]

Target	Description
input	Specifies an input
bank	Specifies an EDID bank

*param4* Target [1 ... 8]

Value	Description
1 ... 16	Input
1 ... 8	EDID bank

(continued on next page)

Notes:

If *param1* = default or *param1* = dynamic, set *param2* = 0.

Using Dynamic EDID

When *param1* = dynamic, the specified input will be set to *Dynamic EDID*. This can be observed by accessing the Manage EDID tab, in the Web interface. When an input is set to *Dynamic EDID*, the input will use the EDID of the last selected output during the routing process. The order in which outputs are routed are important when using *Dynamic EDID*. See the example below.

Examples:

Using Dynamic EDID:

```
#set_edid dynamic 0 input 4
COPY DYNAMIC EDID TO INPUT4.
```

In the example above, Input 4 is set to *Dynamic EDID*. If the following routing command is issued, then the EDID from Output 3 (not Output 2) will be used by Input 1.

```
r 4 2 3
INPUT 4 IS SET TO OUTPUTS 2, 3
```

However, if we wanted to use the EDID from Output 2, we would write the command as:

```
r 4 3 2
INPUT 4 IS SET TO OUTPUTS 3, 2
```

Since Output 2 was the last output that was specified, this will be the EDID that Input 4 will use.

This second example does not use Dynamic EDID but uses the EDID from the specified downstream sink (display, etc):

```
#set_edid output 1 input 3
COPY OUTPUT1 EDID TO INPUT3.
```

## #set\_ir

The #set\_ir command sets the IR channel for the matrix.

### Syntax:

```
#set_ir param1
```

### Parameters:

*param1* Channel [0 ... 3]

Channel	Description
0	Set IR channel 0
1	Set IR channel 1
2	Set IR channel 2
3	Set IR channel 3

### Example:

```
#set_ir 0
```

```
IR CHANNEL IS SET TO CHANNEL 0 (DIP1=OFF, DIP2=OFF)
```



## #show\_fw

The #show\_fw command displays the current version of matrix firmware.

### Syntax:

```
#show_fw
```

### Parameters:

None

### Example:

```
#show_fw
```

```
FIRMWARE VERSION = GEF-HDFST-MOD-16416 v1.0X
```

## #show\_hdcp

The #show\_hdcp command displays the HDCP status on the specified input.

### Syntax:

```
#show_hdcp param1
```

### Parameters:

<i>param1</i>	Input	[1 ... 16]
---------------	-------	------------

### Example:

```
#show_hdcp 1
```

```
INPUT 1 HDCP IS ENABLED
```

## #show\_hpd

The #show\_hpd command displays the HPD status of the specified output. Output 17 is **HDMI Local Out**.

### Syntax:

```
#show_hpd param1
```

### Parameters:

<i>param1</i>	Output	[1 ... 17]
---------------	--------	------------

### Example:

```
#show_hpd 4
```

```
HPD OF OUTPUT 4 (Output4) IS LOW
```

## #show\_ir

The #show\_ir command displays the IR channel of the matrix.

### Syntax:

```
#show_ir
```

### Parameters:

None

### Example:

```
#show_ir
```

```
CURRENT IR CHANNEL IS: 0
```

## #show\_out\_colordpt

The #show\_out\_colordpt command displays the highest color depth supported by the specified display based on the EDID. If no display is attached to the specified output, then the command will return NO SIGNAL. Output 17 is **HDMI Local Out**.

### Syntax:

```
#show_out_colordpt param1
```

### Parameters:

<i>param1</i>	Output	[1 ... 17]
---------------	--------	------------

### Example:

```
#show_out_colordpt 15  
12 BITS HDMI
```

## #show\_out\_res

The #show\_out\_res command displays the highest resolution supported by the specified display based on the EDID. If no display is attached to the specified output, then the command will return NO SIGNAL. Output 17 is **HDMI Local Out**.

### Syntax:

```
#show_out_res param1
```

### Parameters:

<i>param1</i>	Output	[1 ... 17]
---------------	--------	------------

### Example:

```
#show_out_res 15  
1080P 60HZ HDMI
```

## #show\_r

The #show\_out\_colorcpt command displays the current routing status of the specified output. Output 17 is **HDMI Local Out**.

### Syntax:

```
#show_r param1
```

### Parameters:

<i>param1</i>	Output	[1 ... 17]
---------------	--------	------------

### Example:

```
#show_r 9
```

```
OUTPUT 9(Output5) IS ROUTED TO INPUT 5(Input5)
```

## #show\_rsense

The #show\_rsense command displays the RSENSE status of the specified output. Output 17 is **HDMI Local Out**.

### Syntax:

```
#show_rsense param1
```

### Parameters:

<i>param1</i>	Output	[1 ... 16]
---------------	--------	------------

### Example:

```
#show_rsense 6
```

```
RSENSE OF OUTPUT 6 (Output6) IS HIGH
```

## #show\_ver\_data

The #show\_ver\_data command displays the current software and hardware version.

**Syntax:**

```
#show_ver_data
```

**Parameters:**

None

**Example:**

```
#show_ver_data
```

```
SOFTWARE AND HARDWARE VERSION: v1.0X PCB-2026*A
```

**m**

The `m` command displays the current matrix routing status. Do not precede the `m` command with the '#' symbol.

Syntax:

```
m
```

Parameters:

None

Example:

```
m
```

```
OUT: 01 02 03 04 05 06 07 08  
IN:  03 03 03 03 03 03 03 03
```

```
OUT: 09 10 11 12 13 14 15 16  
IN:  03 03 03 03 03 03 03 03
```

```
OUT: 17  
IN:  03
```

```
ALL OUTPUTS ARE UNMASKED  
MATRIX IS UNLOCKED
```

**n**

The `n` command displays the routing status of the specified output. Do not precede the `n` command with the “#” symbol. If `param1 = 0`, then the routing status for all outputs will be returned.

**Syntax:**

```
n param1
```

**Parameters:**

*None*

**Examples:**

To see how this command works, we have already routed Input 2 to Outputs 4, 5, and 9. Now, we'll use the `n` command to query Output 4:

```
n 4
O04I03
```

The feedback is abbreviated as: “O04I03” and is read as: “Output 04 Input 03”

We can also query all outputs by setting `param1 = 0`:

```
n 0
OUT: 01 02 03 04 05 06 07 08
    IN: 08 06 08 08 08 08 08 08
OUT: 09 10 11 12 13 14 15 16
    IN: 08 08 08 08 08 08 08 08
OUT: 17
    IN: 08
```

# Web Interface

## Using the built-in Web Server

Access the built-in Web interface by entering the IP address of the matrix that was specified in step 3 under [IP / UDP Configuration](#). Once connected to the matrix, the login screen will be displayed.

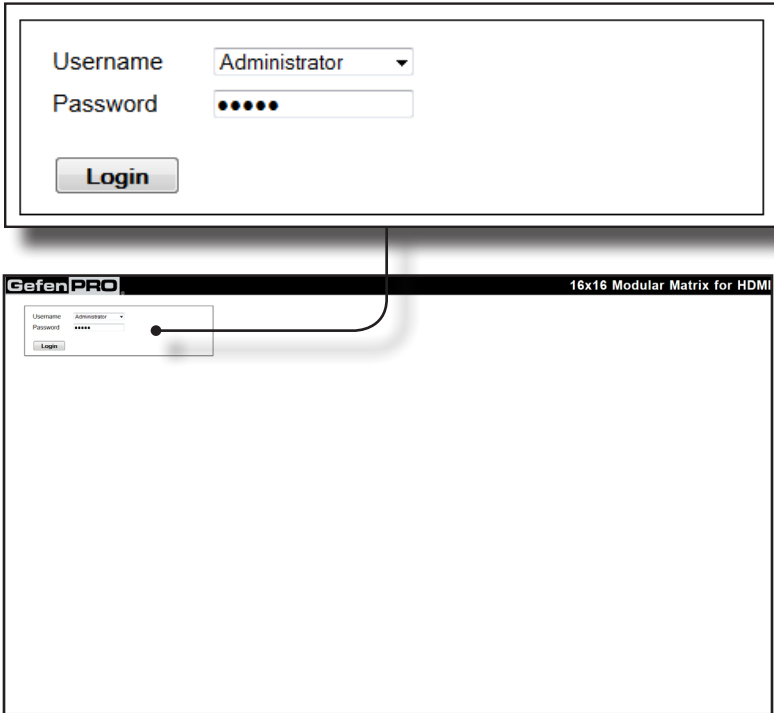

### Username

Select the username from the drop-down list.

### Options:

Operator, Administrator

Administrator login provides unrestricted access to all features and settings. Operator login limits access to matrix routing, display information, and routing preset features.

### Password

Enter the password for the associated username. The password can also be set using RS-232 or Telnet. See the `#set_webui_op_pass` and the `#set_webui_ad_pass` commands.



The Web GUI is divided into four main pages: **Main**, **I/O Setup**, **Manage EDID**, and **Configuration**. Each main page is represented by a tab at the top-most portion of the screen. The **Main**, **I/O Setup**, and **Manage EDID** pages have their own set of sub-tabs. Click on the desired tab / sub-tab to open the desired page.

**i NOTE:** In order to view all four tabs at the top of the screen, the user must be logged in as “Administrator”. If logged-in as “Operator”, only the **Main** tab will be visible.

### Main Routing

#### Log Out

Click **Log Out** to terminate the current Web session and return to the login page.

#### Power (On / Standby)

Click to toggle between power-on and standby mode.

Power

**Status**

Output	Input #
1	1
2	1
3	1
4	3
5	1
6	1
7	1
8	3
9	3
10	3
11	1
12	3
13	3
14	3
15	3
16	1
17-Local	3

**Routing**

Output #	Type	Name	Output	Input #	Name	Type
1	HDMI	Output1	1	1	Input1	HDMI
2	HDMI	Output2	2	2	Input2	HDMI
3	HDMI	Output3	3	3	Input3	HDMI
4	HDMI	Output4	4	4	Input4	HDMI
5	HDMI	Output5	5	5	Input5	HDMI
6	HDMI	Output6	6	6	Input6	HDMI
7	HDMI	Output7	7	7	Input7	HDMI
8	HDMI	Output8	8	8	Input8	HDMI
9	HDMI	Output9	9	9	Input9	HDMI
10	HDMI	Output10	10	10	Input10	HDMI
11	HDMI	Output11	11	11	Input11	HDMI
12	HDMI	Output12	12	12	Input12	HDMI
13	HDMI	Output13	13	13	Input13	HDMI
14	HDMI	Output14	14	14	Input14	HDMI
15	HDMI	Output15	15	15	Input15	HDMI
16	HDMI	Output16	16	16	Input16	HDMI
17-Local	Local	Output17	17-Local	3	Max1 / Local3	Local

**Save & Recall Routing Presets**

Save Routing Preset: 1-Preset1 -

Recall Routing Preset:

#### Status (Output / Input #)

Displays the current routing status of the matrix.

#### 17-Local

This output is used for local A/V monitoring and cannot be routed.

The screenshot shows the Gefen PRO 16x16 Modular Matrix for HDMI web interface. The main window displays a routing configuration page with a table of outputs and inputs. A modal window titled "Inputs" is open, showing a list of inputs from 1 to 16, each with a radio button, a name, and a type. Input 3 is selected. Below the list is a "Mask / Unmask" section and a "Route" button.

Input #	Name	Type
<input type="radio"/>	Input1	HDMI
<input type="radio"/>	Input2	
<input checked="" type="radio"/>	Input3	
<input type="radio"/>	Input4	
<input type="radio"/>	Input5	
<input type="radio"/>	Input6	
<input type="radio"/>	Input14	
<input type="radio"/>	Input15	
<input type="radio"/>	Input16	
<input type="radio"/>	Mask / Unmask	

**Route**

### Input #

Click the radio button next to the desired input to be routed. Only one input can be selected at a time.

### Name

Displays the current name of the input.

### Type

Indicates the type of card that is installed for the listed inputs.

### Mask / Unmask

Click this radio button to enable / disable the selected input.

### Route

Click the **Route** button to route the selected input to the select output(s).

**Gefen PRO** 16x16 Modular Matrix for HDMI

Main: I/O Setup Manage EDIO Configuration Power (Ready) Log Out

Routing I/O Status Display Info

Lock Matrix

Status		Outputs				Inputs			
Output	Input #	Type	Name	Output	Input #	Name	Type		
1	1		Output1	1	1	Input1			
2	1		Output2	2	2	Input2			
3	1		Output3	3	3	Input3			
4	3	HDMI	Output4	4	4	Input4	HDMI		
5	3		Output5	5	5	Input5			
6	1		Output6	6	6	Input6			
7	3		Output7	7	7	Input7			
8	3		Output8	8	8	Input8			
9	3		Output9	9	9	Input9			
10	3		Output10	10	10	Input10			
11	1		Output11	11	11	Input11			
12	3	HDMI	Output12	12	12	Input12	HDMI		
13	3		Output13	13	13	Input13			
14	3		Output14	14	14	Input14			
15	3		Output15	15	15	Input15			
16	1		Output16	16	16	Input16			
17-Local	3		Output17	17-Local	17	Input17			

Check All Clear All

Save & Recall Routing

Save Routing Preset: 1-Preset

Recall Routing Preset: Preset1 Preset2 Preset3 Preset4 Preset5 Preset6 Preset7 Preset8

Admin HDBP HDBS Fail Local

Outputs		
Type	Name	Output
	Output1	1
	Output2	2
	Output3	3
HDMI	Output4	4
	Output5	5
	Output6	6
	Output14	14
	Output15	15
	Output16	16
	Output17	17-Local

Check All Clear All

**Output**

Click to place a check mark in the box and select the desired output. Multiple outputs can be selected. This includes the local A/V output (17-Local).

**Name**

Displays the current name of the output.

**Type**

Indicates the type of card that is installed for the listed outputs.

**Check All**

Click this button to select all outputs.

**Clear All**

Click this button to clear (deselect) all selected outputs

### Lock Matrix

Locks / unlocks the matrix. Once the matrix is locked, settings on the matrix cannot be changed using the front-panel buttons or through the Web GUI. When the matrix is locked, the button text will read “Unlock Matrix” and a red bar will appear across the top portion of the screen with the text “Matrix is LOCKED”. Click the “Unlock Matrix” button to unlock the matrix.

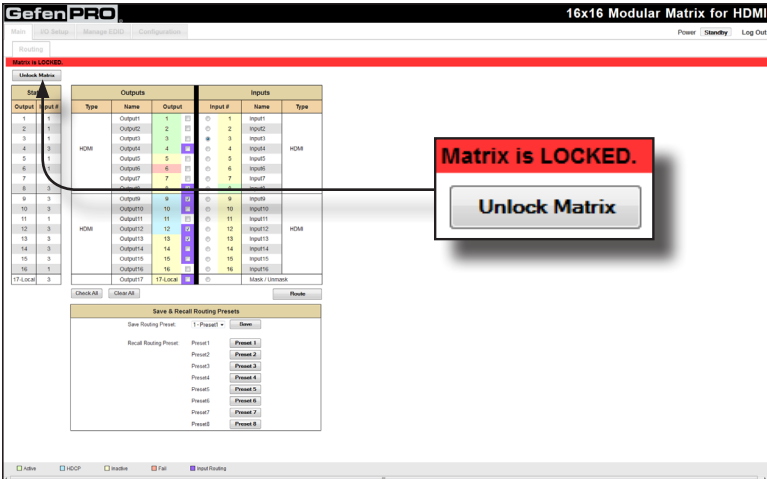
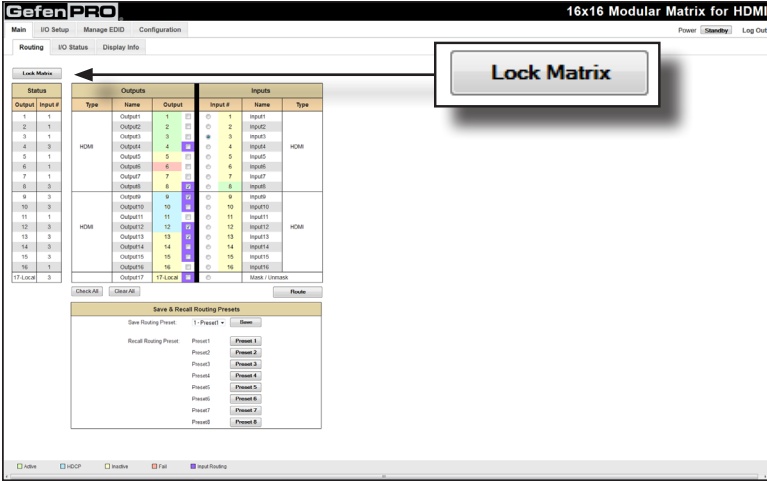

**GefenPRO** 16x16 Modular Matrix for HDMI

Main: I/O Setup Manage EDID Configuration Power (Ready) Log Out

Routing I/O Status Display Info

Lock Matrix

Status		Outputs				Inputs			
Output	Input#	Type	Name	Output	Input #	Name	Type		
1	1		Output1	1	1	Input1			
2	1		Output2	2	2	Input2			
3	1	HDMI	Output3	3	3	Input3	HDMI		
4	1		Output4	4	4	Input4			
5	1		Output5	5	5	Input5			
6	1		Output6	6	6	Input6			
7	1		Output7	7	7	Input7			
8	1		Output8	8	8	Input8			
9	2		Output9	9	9	Input9			
10	2		Output10	10	10	Input10			
11	1		Output11	11	11	Input11			
12	2	HDMI	Output12	12	12	Input12	HDMI		
13	2		Output13	13	13	Input13			
14	2		Output14	14	14	Input14			
15	2		Output15	15	15	Input15			
16	1		Output16	16	16	Input16			
17	Local		Output17	17	Local	Matrix / Unassigned			

Save & Recall Routing Presets

Save Routing Preset: 1 - Preset1 Save

Recall Routing Preset: Preset1 Preset 1  
Preset2 Preset 2  
Preset3 Preset 3  
Preset4 Preset 4  
Preset5 Preset 5  
Preset6 Preset 6  
Preset7 Preset 7  
Preset8 Preset 8

### Save Routing Preset

Saves the current routing state to memory. Click the drop-down list to select the desired routing preset. Click the **Save** button to save the preset to memory.

### Recall Routing Preset

Loads the selected routing state into memory. Click the desired button to load the desired routing preset into memory.

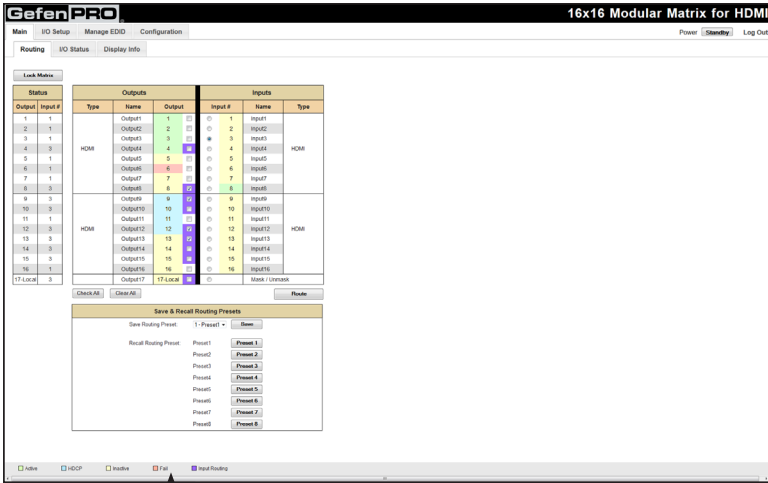

**Legend**

Provides color-coded information on the status of each Input and Output.

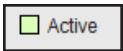

Indicates that the Input / Output is active (connected to a source or a sink).

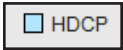

Indicates that an HDCP source is being used on the input.

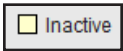

No input source or output (sink) is connected.

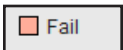

This error indicates that the source is unable to communicate with the display (sink) device.

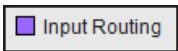

Displays the current routing status of an input when a radio button, under the Input # column, is selected.

## Main I/O Status

**Gefen PRO** 16x16 Modular Matrix for HDMI

Main I/O Setup Manage EDID Configuration Power **Standby** Log Out

Routing I/O Status Display Info

		Output																
		1	2	3	4	5	6	7	8	9	10	11	12	13	14	15	16	17-Local
Name	Output	Off	Off	Off	Off	Off	Off	Off	Off	Off	Off	Off	Off	Off	Off	Off	Off	Off
RSense	Off	Off	Off	Off	Off	Off	Off	Off	Off	Off	Off	Off	Off	Off	Off	Off	Off	Off
Mask	Off	Off	Off	Off	Off	Off	Off	Off	Off	Off	Off	Off	Off	Off	Off	Off	Off	Off
HPD	Low	Low	Low	Low	Low	Low	Low	Low	Low	Low	Low	Low	Low	Low	Low	Low	Low	Low
HDCP	Inactive	Inactive	Inactive	Inactive	Inactive	Inactive	Inactive	Inactive	Inactive	Inactive	Inactive	Inactive	Inactive	Inactive	Inactive	Inactive	Inactive	Inactive
Video Mode	HDMI	HDMI	HDMI	HDMI	HDMI	HDMI	HDMI	HDMI	HDMI	HDMI	HDMI	HDMI	HDMI	HDMI	HDMI	HDMI	HDMI	HDMI

		1	15	16	17-Local
Name	Output1	Output15	Output16	N/A	
RSense	Off	Off	Off	N/A	
Mask	Off	Off	Off	N/A	
HPD	Low	Low	Low	N/A	
HDCP	Inactive	Inactive	Inactive	N/A	
Video Mode	HDMI	HDMI	HDMI	N/A	

### Output

Displays the state of each output for each of the following: Name, RSENSE, Mask, HPD (Hot-Plug Detect), and HDCP.

### Name

Displays the name of the output. The name of the output can be changed using the Web GUI (I/O Setup ► I/O Names) or using the `#set_output_name` command.

### RSENSE

Displays the current Rsense state.

### Mask

Displays the masking state of each output.

### HPD

Displays the Hot-Plug Detect (HPD) state of each output.

### HDCP

Indicates if HDCP-detection is enabled or disabled on each output.

### Video Mode

Displays the current output video mode.

GefenPRO 16x16 Modular Matrix for HDMI																	
Main: I/O Setup Manage EDD Configuration Power: (Ready) Log Out																	
Routing I/O Status Display Info																	
Output																	
Name	1	2	3	4	5	6	7	8	9	10	11	12	13	14	15	16	17:Local
Source	Output	Output	Output	Output	Output	Output	Output	Output	Output	Output	Output	Output	Output	Output	Output	Output	Output
Color Depth	CE	CE	CE	CE	CE	CE	CE	CE	CE	CE	CE	CE	CE	CE	CE	CE	CE
Color Space	CE	CE	CE	CE	CE	CE	CE	CE	CE	CE	CE	CE	CE	CE	CE	CE	CE
HDCP	CE	CE	CE	CE	CE	CE	CE	CE	CE	CE	CE	CE	CE	CE	CE	CE	CE
3D	CE	CE	CE	CE	CE	CE	CE	CE	CE	CE	CE	CE	CE	CE	CE	CE	CE
Active Signal	Inactive	Inactive	Inactive	Inactive	Inactive	Inactive	Inactive	Inactive	Inactive	Inactive	Inactive	Inactive	Inactive	Inactive	Inactive	Inactive	Inactive
Vertical Resolution	HDMI	HDMI	HDMI	HDMI	HDMI	HDMI	HDMI	HDMI	HDMI	HDMI	HDMI	HDMI	HDMI	HDMI	HDMI	HDMI	HDMI
Horizontal Resolution																	
Progressive / Interlaced																	
Refresh Rate																	
Video Mode	HDMI	HDMI	HDMI	HDMI	HDMI	HDMI	HDMI	HDMI	HDMI	HDMI	HDMI	HDMI	HDMI	HDMI	HDMI	HDMI	HDMI
Input																	
Name	input1	input2	input3	input4	input5	input6	input7	input8	input9	input10	input11	input12	input13	input14	input15	input16	
Color Depth	-	-	-	-	-	-	-	-	-	-	-	-	-	-	-	-	-
Color Space	-	-	-	-	-	-	-	-	-	-	-	-	-	-	-	-	-
HDCP	No	No	No	No	No	No	No	No	No	No	No	No	No	No	No	No	No
3D	No	No	No	No	No	No	No	No	No	No	No	No	No	No	No	No	No
Active Signal	No	No	No	No	No	No	No	No	No	No	No	No	No	No	No	No	No
Vertical Resolution	-	-	-	-	-	-	-	-	-	-	-	-	-	-	-	-	-
Horizontal Resolution	-	-	-	-	-	-	-	-	-	-	-	-	-	-	-	-	-
Progressive / Interlaced	-	-	-	-	-	-	-	-	-	-	-	-	-	-	-	-	-
Refresh Rate	-	-	-	-	-	-	-	-	-	-	-	-	-	-	-	-	-
Video Mode	HDMI	HDMI	HDMI	HDMI	HDMI	HDMI	HDMI	HDMI	HDMI	HDMI	HDMI	HDMI	HDMI	HDMI	HDMI	HDMI	HDMI

		Input				
		1	7	8	9	10
Name	Input1	Input7	Input8	Input9	Input10	
Color Depth	-	-	-	-	-	-
Color Space	-	-	-	-	-	-
HDCP	No	No	No	No	No	No
3D	No	No	No	No	No	No
Active Signal	No	No	No	No	No	No
Vertical Resolution	-	-	-	-	-	-
Horizontal Resolution	-	-	-	-	-	-
Progressive / Interlaced	-	-	-	-	-	-
Refresh Rate	-	-	-	-	-	-
Video Mode	HDMI	HDMI	HDMI	HDMI	HDMI	HDMI

**Input**

Displays the state of each input for each of the following: Input name, Color Depth, Color Space, HDCP, 3D, Active Signal, Vertical Resolution, Horizontal Resolution, Progressive / Interlaced, and Refresh Rate.



Main  Display Info

Choose EDID Default EDID

**GefenPRO** 16x16 Modular Matrix for HDMI

Main I/O Setup Manage EDID Configuration Power (Standby) Log Out

Routing I/O Status **Display Info**

Choose EDID Default EDID

Feature	
24Hz Frame Rate	TRUE
Max Resolution	1080P@60Hz
Max Color Depth	12 bit
3D Capable	FALSE
Mode (DVI/HDMI)	HDMI
Max Audio Channels	2 Ch
Monitor Name	HDMI-DA
Audio Formats	
LPCM	TRUE
DTS-HD	FALSE
DTS Digital Surround	FALSE
Dolby Digital (AC3)	FALSE
Dolby TrueHD	FALSE

**Choose EDID**

Select the EDID from the drop-down list. The selected EDID will be copied from the selected EDID Bank or Output to the desired input(s) and used by the source.

**Options:**

Default EDID, Bank 1 ... Bank 8, Output 1 ... Output 16, 17-Local

**Feature / Audio Formats**

Displays the capabilities of the display (or sink device), based on the EDID.

I/O Setup  Preset Names

The screenshot shows the 'Edit Preset Names' dialog box in the Gefen PRO web interface. The dialog box contains a table with 8 rows, each representing a preset. The columns are 'Preset #' and 'Name'. The names are currently 'Preset1' through 'Preset8'. Below the table are two buttons: 'Save Changes' and 'Cancel'.

Preset #	Name
1	Preset1
2	Preset2
3	Preset3
4	Preset4
5	Preset5
6	Preset6
7	Preset7
8	Preset8

**Name**

Type the desired name of the Preset in this field.

Click the **Save Changes** button to save the Name.

Click the **Cancel** button to cancel any changes and restore the previous name.

**Save Changes**

Saves the current changes.

**Cancel**

Restores the previous names for each Preset, if a change was made.

I/O Setup  I/O Names

**Gefen PRO** 16x16 Modular Matrix for HDMI

Main I/O Setup Manage EDID Configuration Preset Names I/O Names HPD Control FST HDCP Power Standby Log Out

**Edit Output & Input Names**

Output	Name	Input #	Name
1	Output1	1	Input1
2	Output2	2	Input2
3	Output3	3	Input3
4	Output4	4	Input4
5	Output5	5	Input5
6	Output6	6	Input6
7	Output7	7	Input7
8	Output8	8	Input8
9	Output9	9	Input9
10	Output10	10	Input10
11	Output11	11	Input11
12	Output12	12	Input12
13	Output13	13	Input13
14	Output14	14	Input14
15	Output15	15	Input15
16	Output16	16	Input16
17-Local	Output17		

**Edit Output & Input Names**

Output	Name	Input #	Name
1	<input type="text" value="Output1"/>	1	<input type="text" value="Input1"/>
2	<input type="text" value="Output2"/>	2	<input type="text" value="Input2"/>
3	<input type="text" value="Output3"/>	3	<input type="text" value="Input3"/>
4	<input type="text" value="Output4"/>	4	<input type="text" value="Input4"/>
5	<input type="text" value="Output5"/>	5	<input type="text" value="Input5"/>
6	<input type="text" value="Output6"/>	6	<input type="text" value="Input6"/>
13	<input type="text" value="Output13"/>	13	<input type="text" value="Input13"/>
14	<input type="text" value="Output14"/>	14	<input type="text" value="Input14"/>
15	<input type="text" value="Output15"/>	15	<input type="text" value="Input15"/>
16	<input type="text" value="Output16"/>	16	<input type="text" value="Input16"/>
17-Local	<input type="text" value="Output17"/>		

**Save Changes** **Cancel**

**Name**

Type the desired name of each Output or Input in these fields.

**Save Changes**

Click this button to save the Input / Output name.

**Cancel**

Click this button to cancel the name change(s).

I/O Setup  HPD Control

The screenshot shows the 'HPD Control' configuration page in the Gefen PRO web interface. The page title is '16x16 Modular Matrix for HDMI'. The navigation menu includes Main, I/O Setup, Manage EDID, Configuration, Power, Standby, and Log Out. The HPD Control section is active, showing a table with 16 rows. Each row has an 'Input #' column, a 'Name' column, and a 'Pulse' button. The first four rows are highlighted in orange, and the last four rows are highlighted in grey. A callout box highlights the first four rows, and another callout box highlights the last four rows.

HPD Control		
Input #	Name	
1	Input1	Pulse
2	Input2	Pulse
3	Input3	Pulse
4	Input4	Pulse
11	Input11	Pulse
12	Input12	Pulse
13	Input13	Pulse
14	Input14	Pulse
15	Input15	Pulse
16	Input16	Pulse

**Pulse**

Click the Pulse button to cycle the HPD line on the desired input. This is the equivalent of physically disconnecting and reconnecting the HDMI cable between the source device and the matrix.

I/O Setup  FST

The screenshot shows the Gefen PRO web interface for a 16x16 Modular Matrix for HDMI. The 'I/O Setup' tab is active, and the 'FST' sub-tab is selected. A modal dialog titled 'Fast Switching Technology' is displayed, allowing users to configure FST for each input. The dialog contains a table with columns for 'FST', 'Input #', and 'Name'. Each row represents an input from 1 to 16, with radio buttons for 'Fast' (selected) and 'Slow'. 'Set' and 'Cancel' buttons are at the bottom of the dialog.

Fast Switching Technology		
FST	Input #	Name
<input checked="" type="radio"/> Fast <input type="radio"/> Slow	1	Input1
<input checked="" type="radio"/> Fast <input type="radio"/> Slow	2	Input2
<input checked="" type="radio"/> Fast <input type="radio"/> Slow	3	Input3
<input checked="" type="radio"/> Fast <input type="radio"/> Slow	4	Input4
<input checked="" type="radio"/> Fast <input type="radio"/> Slow	5	Input5
<input checked="" type="radio"/> Fast <input type="radio"/> Slow	6	Input6
<input checked="" type="radio"/> Fast <input type="radio"/> Slow	13	Input13
<input checked="" type="radio"/> Fast <input type="radio"/> Slow	14	Input14
<input checked="" type="radio"/> Fast <input type="radio"/> Slow	15	Input15
<input checked="" type="radio"/> Fast <input type="radio"/> Slow	16	Input16

**FST**

Click to select / deselect the desired input(s). Inputs with a check mark will enable the FST feature. FST is enabled by default. Use the **Set** button to save changes.

**Check All**

Places a check mark in each box under the FST column.

**Clear All**

Clears all check marks from the FST column.

**Set**

Click this button to save changes for all input(s). The Web GUI will display a prompt to verify the selected operation.

**Cancel**

Cancel the current operation and ignores changes for each input, if a change was made.

I/O Setup  HDCP

**NOTE:** Some computers will enable HDCP if an HDCP-compliant display is detected. Use the Disable feature to force the computer to ignore detection of an HDCP-compliant display. The Disable feature does not decrypt HDCP content.

HDCP Pass Through		
Disable	Input #	Name
<input type="checkbox"/>	1	Input1
<input type="checkbox"/>	2	Input2
<input type="checkbox"/>	3	Input3
<input type="checkbox"/>	4	Input4
<input type="checkbox"/>	5	Input5
<input type="checkbox"/>	6	Input6
<input type="checkbox"/>	7	Input7
<input type="checkbox"/>	8	Input8
<input type="checkbox"/>	9	Input9
<input type="checkbox"/>	10	Input10
<input type="checkbox"/>	11	Input11
<input type="checkbox"/>	12	Input12
<input type="checkbox"/>	13	Input13
<input type="checkbox"/>	14	Input14
<input type="checkbox"/>	15	Input15
<input type="checkbox"/>	16	Input16

Buttons: Check All, Clear All, Set, Cancel

**Disable**

Click to select / deselect the desired input(s). Inputs with a check mark will *disable* the HDCP feature. Use the **Set** button to save changes.

**Check All**

Places a check mark in each box under the Disable column.

**Clear All**

Clears all check marks from the Disable column.

**Set**

Click this button to save changes for all input(s). The Web GUI will display a prompt to verify the selected operation.

**Cancel**

Cancel the current operation and ignores changes for each input, if a change was made.

## Manage EDID Assign

### Lock EDID

Secures the Local EDID and disables automatic EDID loading during power-up.

If the **Lock EDID** button is clicked (enabled), the “EDID locked on power cycle” message will be displayed in red. The local EDID information will now be locked once the matrix is rebooted. Click the **Unlock EDID** button to disable the Lock EDID feature.

The diagram illustrates the EDID management workflow. It shows a 'Lock EDID' button, an 'Unlock EDID' button, and a red notification box stating 'EDID locked on power cycle.'. Below this, a screenshot of the 'Gefen PRO' web interface is shown. The interface has a navigation bar with 'Main', 'IO Setup', 'Manage EDID', and 'Configuration'. Under 'Manage EDID', there are tabs for 'Assign', 'Bank Names', and 'Upload/Download'. A 'Copy EDID From' dropdown menu is highlighted, showing a list of inputs and banks. The dropdown is currently set to 'Default EDID'.

Copy To	EDID Source	Input #	Name	EDID Source	EDID Name
<input type="checkbox"/>	Custom	1	Input1	Output1	ParanoteTV01
<input type="checkbox"/>	Custom	2	Input2	Output1	ParanoteTV01
<input type="checkbox"/>	Custom	3	Input3	Output1	ParanoteTV01
<input type="checkbox"/>	Custom	4	Input4	Output1	ParanoteTV01
<input type="checkbox"/>	Custom	5	Input5	Output1	ParanoteTV01
<input type="checkbox"/>	Custom	6	Input6	Output1	ParanoteTV01
<input type="checkbox"/>	Custom	7	Input7	Output1	ParanoteTV01
<input type="checkbox"/>	Custom	8	Input8	Output1	ParanoteTV01
<input type="checkbox"/>	Custom	9	Input9	Output1	ParanoteTV01
<input type="checkbox"/>	Custom	10	Input10	Output1	ParanoteTV01
<input type="checkbox"/>	Custom	11	Input11	Output1	ParanoteTV01
<input type="checkbox"/>	Custom	12	Input12	Output1	ParanoteTV01
<input type="checkbox"/>	Custom	13	Input13	Output1	ParanoteTV01
<input type="checkbox"/>	Custom	14	Input14	Output1	ParanoteTV01
<input type="checkbox"/>	Custom	15	Input15	Output1	ParanoteTV01
<input type="checkbox"/>	Custom	16	Input16	Output1	ParanoteTV01

Copy To	Input #	Name	EDID Name
<input type="checkbox"/>	1	Bank1	N/A
<input type="checkbox"/>	2	Bank2	N/A
<input type="checkbox"/>	3	Bank3	N/A
<input type="checkbox"/>	4	Bank4	N/A
<input type="checkbox"/>	5	Bank5	N/A
<input type="checkbox"/>	6	Bank6	N/A
<input type="checkbox"/>	7	Bank7	N/A
<input type="checkbox"/>	8	Bank8	N/A

### Copy EDID From

Select the EDID from the drop-down list. The EDID will be copied from the selected destination to the desired input or EDID bank.

Options:

Default EDID, Bank 1 ... Bank 8, Output 1 ... Output 16, Output 17 (Local)



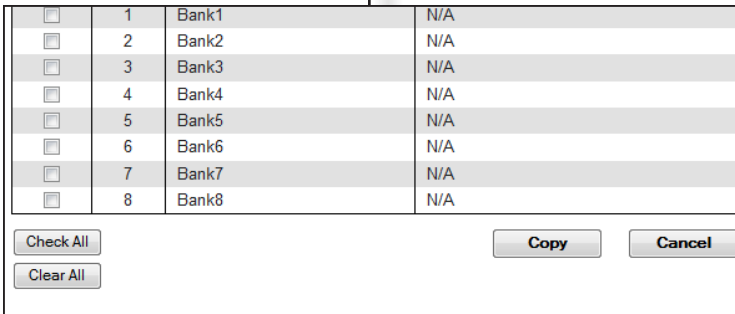
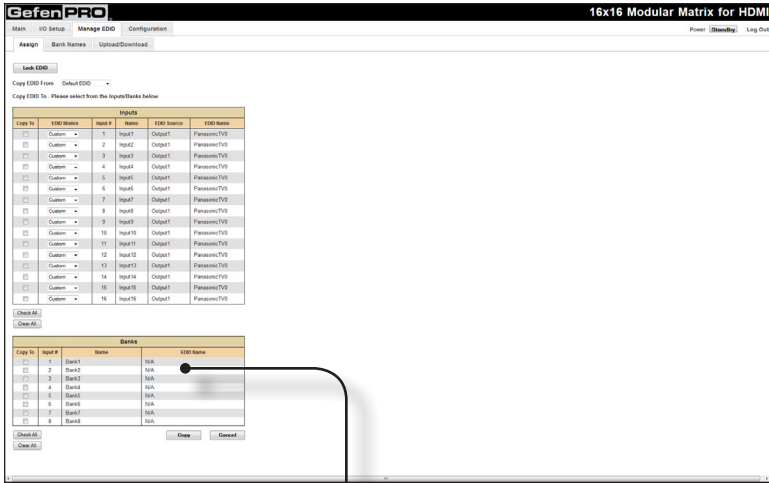

**Check All**

Places a check mark in each box under the **Copy To** column.

**Clear All**

Clears all check marks from the **Copy To** column.

**Copy**

Click this button to copy the specified EDID to the selected inputs / banks.

**Cancel**

Restores the previous EDID state for each input, if a change was made.

## Manage EDID Bank Names

The screenshot shows the 'Gefen PRO' web interface for a '16x16 Modular Matrix for HDMI'. The 'Manage EDID' section is active, and the 'Bank Names' sub-section is selected. A dialog box titled 'Edit Banks Names' is open, displaying a table with 8 rows. Each row has a 'Bank #' column and a 'Name' column. The 'Name' fields are currently filled with 'Bank1' through 'Bank8'. Below the table are two buttons: 'Save Changes' and 'Cancel'.

Bank #	Name
1	Bank1
2	Bank2
3	Bank3
4	Bank4
5	Bank5
6	Bank6
7	Bank7
8	Bank8

### Bank #

Indicates the EDID bank number.

### Name

Type the desired name of the EDID bank in this field.  
Click the **Save Changes** button to save the bank name.  
Click the **Cancel** button to restore the previous name.

### Save Changes

Saves the current name change to the EDID bank(s).

### Cancel

Restores the previous names for each EDID bank, if a change was made.

## Manage EDID Upload/Download

### Browse...

Click this button to select the EDID file to be uploaded.

### Select Bank Location

Click this drop-down list to select the bank to where the EDID will be uploaded.

### Upload

Click this button to upload the EDID to the specified bank.

Options:

Bank 1 ... Bank 8

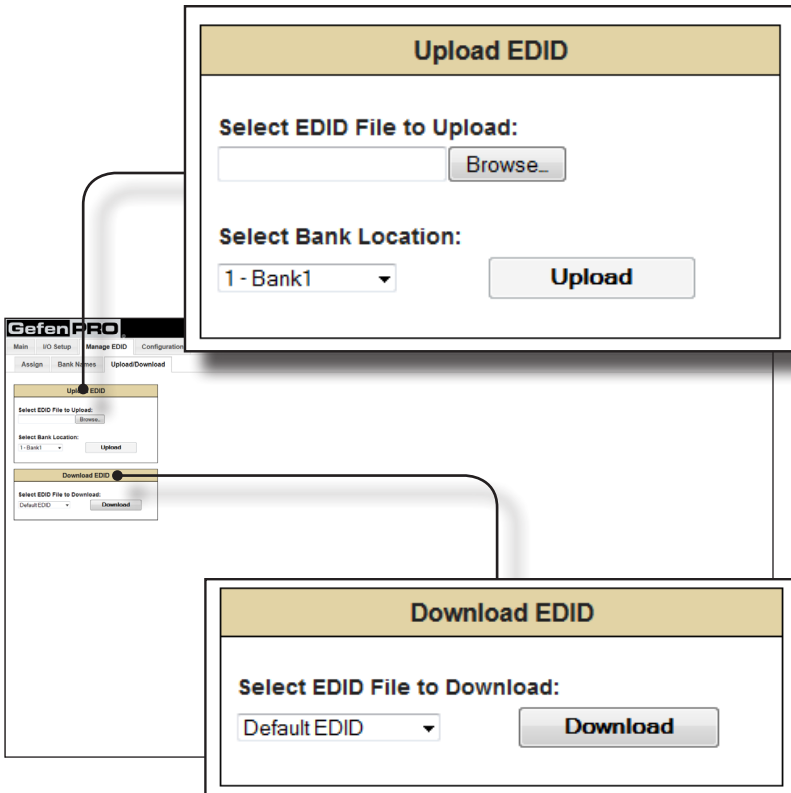

### Select EDID File to Download

Click this box to select the EDID that is to be saved to a file. The EDID file will be saved in binary (.bin) format.

### Download

Click this button to download the selected EDID to a file.

Options:

Bank 1 ... Bank 8, Output 1 ... Output 16, Output 17 (Local),  
Input 1 ... Input 16

## Configuration Change IP Settings

The screenshot shows the 'Change IP Settings' configuration page in the GefenPRO web interface. The page title is 'Change IP Settings' and it is part of the '16x16 Modular Matrix for HDMI' configuration. The settings are as follows:

Change IP Settings	
MAC Address:	00:1c:91:03:70:1c
IP Address:	192.168.2.239
Subnet:	255.255.255.0
Gateway:	192.168.1.1
Port:	80
TCP/Telnet Terminal Port:	23
UDP Port:	50007

At the bottom of the configuration area, there are two buttons: 'Save Settings' and 'Set Defaults'.

### Change IP Settings

Assigns the IP address, subnet, gateway, HTTP listening port, Telnet port, and UDP port. The MAC address cannot be changed.

### Save Settings

Saves the current settings for the Change IP Settings. After clicking this button, the Web interface will display a dialog indicating that the matrix must be rebooted for changes to take effect.

### Set Defaults

Click this button to restore the factory-default IP settings. After clicking this button, the Web interface will display a dialog indicating that the matrix must be rebooted for changes to take effect.

## Configuration Telnet Login Settings

The screenshot shows the 'Telnet Login Settings' configuration page in the GefenPRO web interface. The page is titled 'Telnet Login Settings' and contains the following fields and options:

- Old Password:
- New Password:
- Confirm New Password:
- Force Password on Connect:
- Show Login Message on Connect:

A **Save Settings** button is located at the bottom right of the configuration area.

### Old Password

Type the current (old) password in this field.

### New Password

Type the new password in this field.

### Force Password on Connect

Click this check box to have the matrix prompt for a password each time a Telnet session is started. This box *must* be checked in order to change the Telnet Login credentials.

### Show Login Message on Connect

Click this check box to have the matrix display the Telnet welcome message each time a Telnet session is started. The welcome message appears as: "Welcome to GEF-HDFST-MOD-16416 TELNET".

### Save Settings

Saves the current changes to the Telnet Login Settings.

## Configuration UDP Connection Settings

The screenshot shows the 'UDP Connection Settings' configuration page in the Gefen PRO web interface. The page is titled '16x16 Modular Matrix for HDMI' and includes navigation tabs for 'Main', 'I/O Setup', 'Manage EDID', and 'Configuration'. The 'UDP Connection Settings' section is highlighted with a callout box.

**UDP Connection Settings**

Remote UDP IP Address:

Remote UDP Port:

Enable UDP Access:

**Save Settings**

### Remote UDP IP Address

Type the remote UDP IP address in this text box.

### Remote UDP Port

Enter the remote UDP port in this text box.

### Enable UDP Access

Check this box to enable UDP access. If this box is unchecked, the UDP access will be unavailable.

## Configuration □ Web Login Settings

**Web Login Settings**

Username: Operator

Old Password: ●●●●●

New Password:

Confirm New Password:

**Save Settings**

**Telnet Login Settings**

Old Password:

New Password:

Confirm New Password:

Force Password on Connect:

Show Login Message on Connect:

**Save Settings**

**UDP Connection Settings**

Remove UDP IP Address: 192.168.1.256

Remove UDP Port: 8000

Enable UDP Access:

**Save Settings**

**Web Login Settings**

Username: Operator

Old Password: ●●●●●

New Password:

Confirm New Password:

**Save Settings**

**System Configuration**

Download Current Configuration: **Download**

Restore Configuration: **Restore**

Warning: All current settings will be lost. **Restore**

Firmware Update (3.0 ver: v1.0X): **Update**

Factory Reset: **Reset**

Reboot: **Reboot**

### Username

Click this drop-down list to select the username to be changed.

### Old Password

Type the current (old) password in this field.

### New Password

Type the new password in this field.

### Confirm Password

Re-type the new password in this field.

### Save Settings

Saves the current changes to the Web Login Settings.

## Configuration System Configuration

### System Configuration

Download Current Configuration
Download

Restore Configuration

Browse...

*Warning: All current settings will be lost*

Restore

Firmware Update (UI ver: v1.0X)

Browse...

Update

Factory Reset

Reset

Reboot

Reboot

Telnet Login Settings

Old Password:

New Password:

Confirm New Password:

Force Password on Connect:

Show Login Message on Connect:

[Save Settings](#)

UDP Connection Settings

Remote UDP IP Address: 192.168.1.255

Remote UDP Port: 50000

Enable UDP Access:

[Save Settings](#)

Web Login Settings

Username:  Operator

Old Password:

New Password:

Confirm New Password:

[Save Settings](#)

System Configuration

Download Current Configuration Download

Restore Configuration Browse...

Warning: All current settings will be lost Restore

Firmware Update (UI ver: v1.0X) Update

Factory Reset Reset

Reboot Reboot

### Download

Click this button to download the current matrix configuration to a file.

(continued on next page)



**System Configuration**

Download Current Configuration	<input type="button" value="Download"/>
Restore Configuration	
<input type="text"/> <input type="button" value="Browse_"/>	
<i>Warning: All current settings will be lost</i>	
Firmware Update (UI ver: v1.0X)	
<input type="text"/> <input type="button" value="Browse_"/>	
Factory Reset	<input type="button" value="Reset"/>
Reboot	<input type="button" value="Reboot"/>

**Browse**

Click this button to select the firmware file to be uploaded. See [Upgrading using the Web interface](#) for details on updating the firmware.

**Browse**

Click this button to select the saved configuration file to be loaded into memory.

**Restore**

Uploads the selected configuration file to the matrix.

**Update**

Updates the matrix with the selected firmware file.

**Reset**

Click this button to set the matrix to factory-default settings. The IP settings are preserved.

**Reboot**

Click this button to reboot the matrix.



16<sub>x</sub>16  
sources displays

# Modular Matrix for HDMI with HDCP

## 04 Appendix

Card Removal and Installation .....	122
Power Supply Failure and Replacement .....	125
Power Supply Failure .....	125
Power Supply Replacement .....	126
Firmware Upgrade Procedure .....	128
Upgrading using the Web interface .....	128
Upgrading using USB .....	129
Specifications .....	130

## Card Removal and Installation

Although each 16x16 Modular Matrix for HDMI w/ HDCP is sold pre-configured, both input and output cards can be removed or added to fit the needs of the application. Each module can easily be removed and installed without using any special tools.



**WARNING:** Modules are sensitive to Electrostatic Discharge (ESD) which can damage the module. Avoid touching the module contacts or the components on the module. Always hold modules by the edges or by the knobs on the front of the module. Never slide a module over any surface. When installing/replacing modules, do not install an input module in to an output slot or an output module to an input slot. This will damage the matrix and void the warranty.

1. Power-off the matrix.
2. Turn the matrix around so that you are facing the back of the unit.



**STOP:** Before installing modules and prevent the risk of possible electrical shock, unplug the AC power cord from back of the matrix.

3. Loosen the fastening screws on both sides of the card (or cover plate) to be removed. Each card / cover plate has two fastening screws.



- Grab the fastening screws on both sides of the card, between the thumb and index finger, and gently pull to remove the card from the matrix. If a cover plate is being removed, then loosen the fastening screws on both sides of the cover plate and gently remove the cover plate.

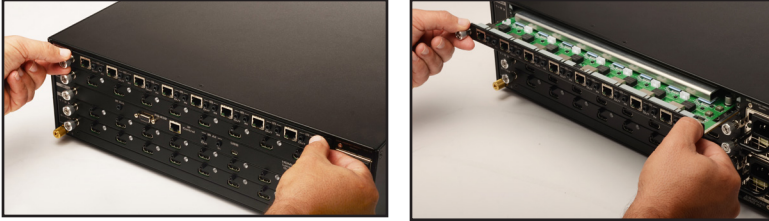

- Locate the grooved track on either side of the expansion bay.

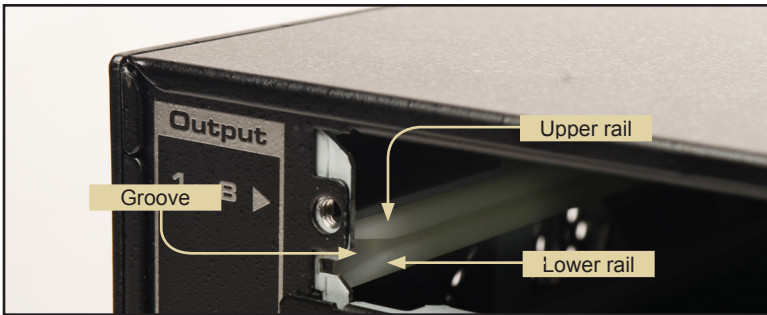

- Carefully position the card between the upper and lower rail on each track.



7. Use both hands to push the card until it snaps in place.



8. Secure the card by hand-tightening the fastening screws. Do not overtighten the screws. To prevent damage to the screws, do not use pliers or other high-torque devices.



# Power Supply Failure and Replacement

## Power Supply Failure

The 16x16 Modular Matrix for HDMI w/ HDCP comes with two internal (hot-swappable) power supplies. If one of these power supplies should fail, a high-pitched alarm will sound from the matrix. `POWER SUPPLY FAILURE!` will appear in the front panel display. The matrix can function with a single power supply. However, the `POWER SUPPLY FAILURE!` message will be displayed instead of the *home screen*, until the power supply is replaced.

If the Web interface is being used, then the following message will appear on the page:

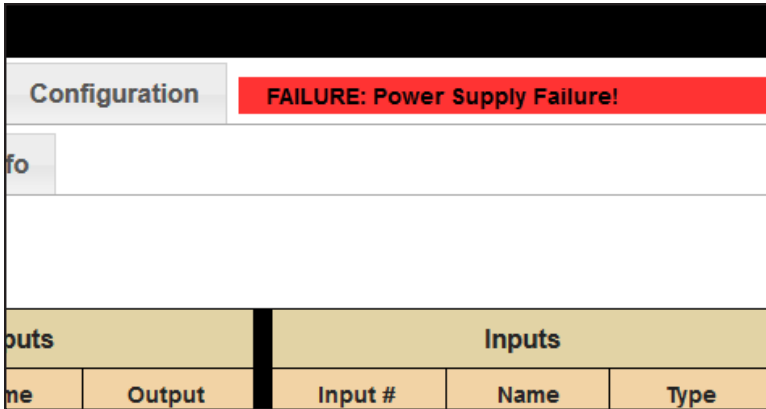

If the matrix is being controlled using RS-232 or Telnet, the `POWER SUPPLY FAILURE!` message will appear within the terminal application.

### Power

Press the Power button to cancel the alarm.



## Power Supply Replacement

1. Press the **Power** button to cancel the alarm. It is not necessary to power-off the matrix when replacing a power supply.
2. Locate the release mechanism on the power supply to be removed (the Gefen 32x32 Matrix for HDMI w/ HDCP is shown).

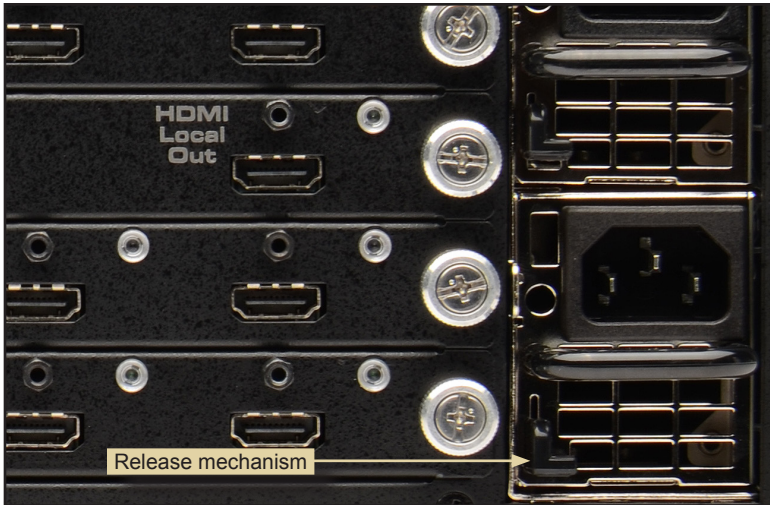

3. Grab the power supply handle and release mechanism between the thumb and index finger and squeeze. The release mechanism will move in an upward direction.

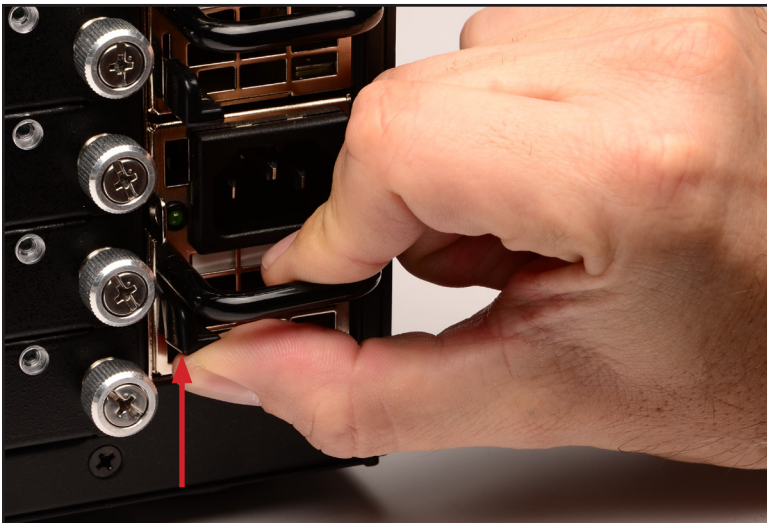



4. Gently pull the power supply as you continue to hold the release mechanism. Once the power supply is released, pull the handle to remove the power supply.



5. Gently push the new power supply into place. The power supply will snap into place once it is fully installed.
6. Check that power supply is secured by pulling on the handle. The power supply should not move without using the release mechanism.

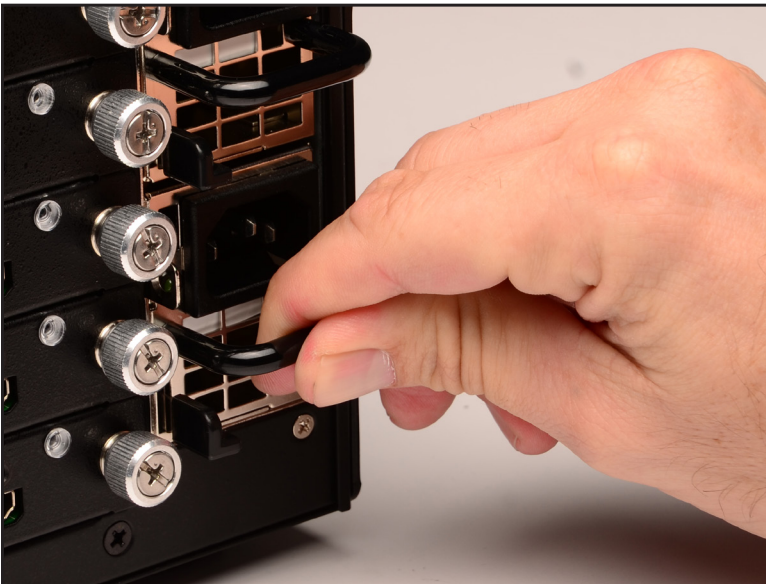

# Firmware Upgrade Procedure

## Upgrading using the Web interface



**IMPORTANT:** *DO NOT* power-off or disconnect the AC power cord from the matrix, at any time, during the firmware upgrade process.

1. Download the firmware update from the Support section of the Gefen Web site.
2. Extract the firmware file from the .ZIP file.
3. Power-ON the 16x16 Modular Matrix for HDMI w/ HDCP.
4. Connect an Ethernet cable between the matrix and the computer running the Web interface.

It is unnecessary to disconnect any cables or extenders from the 16x16 Modular Matrix for HDMI w/ HDCP during the update process.

5. Click the **Configuration** tab in the Web interface and click the **Browse...** button under the **System Configuration** section.
6. Select the firmware file and click the **Update** button.
7. The matrix will display a prompt to verify that the current firmware will be overwritten. Click the **OK** button on the dialog box to begin uploading the firmware file.
8. Once the firmware file has been uploaded, the matrix will verify the firmware content. The front-panel display will display the following if the firmware passes:

CONTENT CHECK:  
PASS

9. After the firmware file integrity has been verified, the matrix will begin the upgrade procedure. The upgrade progress will be displayed in the front-panel display.

-F/W UPDATE-  
35%

10. After the matrix has been updated, the unit will automatically initiate a countdown to reboot. The Power button can be pressed to bypass the countdown without harming the upgrade process. The display will display the following message:

FINISHED  
REBOOT IN 52 SEC

11. After the matrix reboots, the firmware upgrade process will be complete.

## Upgrading using USB



**IMPORTANT:** *DO NOT* power-off or disconnect the AC power cord from the matrix, at any time, during the firmware upgrade process.

1. Download the firmware update from the Support section of the Gefen Web site.
2. Power-ON the 16x16 Modular Matrix for HDMI w/ HDCP.
3. Connect a USB cable between the computer and the 16x16 Modular Matrix for HDMI w/ HDCP.

It is unnecessary to disconnect any cables or extenders from the 16x16 Modular Matrix for HDMI w/ HDCP during the update process.

4. Once the computer is able to connect to the 16x16 Modular Matrix for HDMI w/ HDCP, a Removable disk icon will be displayed under My Computer.
5. Extract the firmware file from the .ZIP file and drag the .bin file to the Removable Disk.
6. Disconnect the USB cable from the computer.
7. The matrix will verify the firmware content. The front-panel display will show the following if the firmware passes.

```
CONTENT CHECK:  
PASS
```

8. After the firmware file integrity has been verified, the matrix will begin the upgrade procedure. The upgrade progress will be displayed in the front-panel display.

```
-F/W UPDATE-  
35%
```

9. After the matrix has been updated, the unit will automatically initiate a countdown to reboot. The **Power** button can be pressed to bypass the countdown without harming the upgrade process.

```
FINISHED  
REBOOT IN 52 SEC
```

10. After the matrix reboots, the firmware upgrade process will be complete.

# Specifications

Supported Formats	
Resolutions (max.)	<ul style="list-style-type: none"> <li>1080p Full HD</li> </ul>

Electrical	
Maximum Pixel Clock	<ul style="list-style-type: none"> <li>225 MHz</li> </ul>

Connectors	
Inputs (16 x max.) (Organized into 2 banks of 8 each)	<ul style="list-style-type: none"> <li>HDMI Type-A, 19-pin, female</li> </ul>
Outputs (16 x max.) (Organized into 2 banks of 8 each)	<ul style="list-style-type: none"> <li>HDMI Type-A, 19-pin, female</li> <li>ELR-POL, RJ-45</li> </ul>
RS-232	<ul style="list-style-type: none"> <li>1 x DB-9, female</li> </ul>
Ethernet	<ul style="list-style-type: none"> <li>RJ-45 (100BaseT)</li> </ul>
USB (for firmware update only)	<ul style="list-style-type: none"> <li>1 x Mini-B, female</li> </ul>
IR Sensor	<ul style="list-style-type: none"> <li>1 x Optical, front panel</li> </ul>
IR Extender (Matrix)	<ul style="list-style-type: none"> <li>1 x 3.5mm mini-stereo</li> </ul>
IR Extender (Receiver)	<ul style="list-style-type: none"> <li>1 x 3.5mm mini-stereo</li> </ul>
IR In (Matrix)	<ul style="list-style-type: none"> <li>1 x 3.5mm mini-mono</li> <li>ELR card: 8 x 3.5mm mini-mono (per output)</li> </ul>
IR Out (Matrix)	<ul style="list-style-type: none"> <li>1 x 3.5mm mini-mono</li> <li>ELR card: 8 x 3.5mm mini-mono (per output)</li> </ul>
IR Out (Receiver)	<ul style="list-style-type: none"> <li>1 x 3.5mm mini-mono</li> </ul>

Operational	
Power Input	• 2 x 100 - 240V AC (hot-swappable)
Power Consumption	• 500W (each power supply)

Physical	
Dimensions (W x H x D) (Matrix w/o feet)	• 17.4" x 5.1" x 16.8" (440mm x 130mm x 427mm) (w/o feet)
Dimensions (W x H x D) (Receiver)	• 4.3" x 1" x 3.3" (108mm x 26mm x 83mm)
Unit Weight	• 30.6 lbs (13.9 kg)



Stretch it, Switch it, Split it, Control it.  
Gefen's got it. ®

20600 Nordhoff St., Chatsworth CA 91311  
1-800-545-6900 818-772-9100 fax: 818-772-9120  
[www.gefenpro.com](http://www.gefenpro.com) [support@gefenpro.com](mailto:support@gefenpro.com)



This product uses UL or CE listed power supplies.